

Sawhorse-type diruthenium tetracarbonyl complexes

Bruno Therrien, Georg Süss-Fink*

Institut de Chimie, Université de Neuchâtel, Case postale 158, CH-2009 Neuchâtel, Switzerland

Contents

1. Introduction	2639
2. Synthetic methods	2642
3. Carboxylato and carboxamido derivatives	2644
4. Pyrazolato, amido, triazenido, pyridinato, pyridonato, oximato and thiazolato derivatives	2647
5. Sulfonato, thiolato and selenolato derivatives	2650
6. Phosphato, phosphinato, phosphinito and phosphido derivatives	2652
7. Other derivatives	2654
8. Catalytically active Ru ₂ (CO) ₄ complexes	2654
9. Mesomorphic Ru ₂ (CO) ₄ complexes	2659
10. Macrocyclic Ru ₂ (CO) ₄ complexes	2659
11. Biologically active Ru ₂ (CO) ₄ complexes	2663
12. Outlook	2663
Acknowledgements	2663
References	2663

A B S T R A C T

The review covers dinuclear ruthenium complexes that contain a Ru₂(CO)₄ backbone arranged in a typical sawhorse geometry as well as two three-electron bridges and two terminal two-electron ligands. Synthetic and structural aspects of these complexes are presented, and their catalytic and biological properties as well as their potential applications for nano-materials are reviewed.

Keywords:

Ruthenium, Carbonyl, Sawhorse, Carboxylato, Carboxamido, Amido, Pyrazolato, Triazenido, Pyridonato, Oximato, Sulfonato, Thiolato, Selenolato, Phosphato, Phosphinato, Phosphinito, Phosphido

1. Introduction

The discovery of diruthenium tetracarbonyl complexes goes back forty years ago, when Lewis and co-workers in Cambridge studied the reaction of triruthenium and triosmium dodecacarbonyl with various carbonic acids RCOOH: refluxing Ru₃(CO)₁₂ in

☆ Dedicated to the Lord Lewis of Newnham (Professor Jack Lewis), a great scientist and friend.

* Corresponding author. Tel.: +41 32 718 2405; fax: +41 32 718 2511.
E-mail address: georg.suess-fink@unine.ch (G. Süss-Fink).

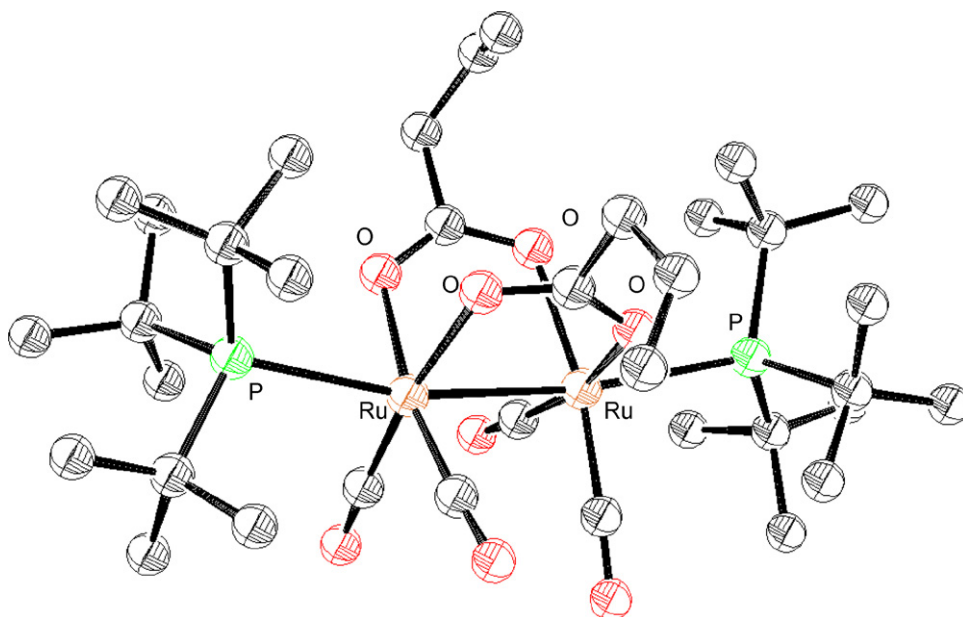
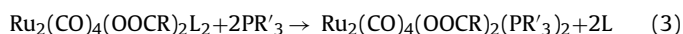
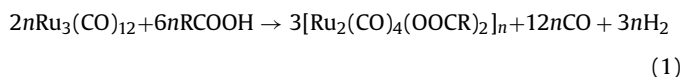

Fig. 1. Molecular structure of $\text{Ru}_2(\text{CO})_4(\text{OOCPr}^n)_2(\text{PBu}^t_3)_2$ [2].

formic, acetic or propionic acid produced polymeric materials to which the formula $[\text{Ru}(\text{CO})_2(\text{OOCR})]_n$ was assigned on the basis of their infrared and micro-analytical data. These polymers were found to dissolve in coordinating solvents L such as tetrahydrofuran, acetonitrile or pyridine to form dinuclear complexes assumed to be $\text{Ru}_2(\text{CO})_4(\text{OOCR})_2\text{L}_2$ that lose the coordinated molecules L upon evaporation of the solvent and go back to the polymers $[\text{Ru}(\text{CO})_2(\text{OOCR})]_n$. The dinuclear nature of these solvent complexes was deduced from their reaction with phosphines PR'_3 , leading to the corresponding phosphine complexes $\text{Ru}_2(\text{CO})_4(\text{OOCR})_2(\text{PR}'_3)_2$ according to Eqs. (1)–(3), complexes which have been isolated and fully characterized [1]



In this pioneering study, the structure of these dinuclear complexes was proposed entirely on the basis of mass, NMR and, in particular, of infrared spectroscopy. The bridging $\mu^2\text{-}\eta^2\text{-O,O}$ coordination mode of the carboxylato ligands was deduced from the two characteristic IR absorptions between 1550 and 1400 cm^{-1} , assigned to the symmetrical and asymmetrical $\nu(\text{OCO})$ vibrations; the $\text{Ru}_2(\text{CO})_4$ backbone with four terminal all-*cis* carbonyl ligands was presumed in the light of symmetry arguments (point group C_{2v}) from the typical $\nu(\text{CO})$ three-band signature around 2000 cm^{-1} [1].

The molecular constitution of these dinuclear complexes was confirmed in 1977, when Schumann et al. performed a single-crystal X-ray structure analysis of the tri(*t*-butyl)phosphine derivative of the butyrate complex $\text{Ru}_2(\text{CO})_4(\text{OOCPr}^n)_2(\text{PBu}^t_3)_2$ [2], which was synthesized from $\text{Ru}_3(\text{CO})_{12}$, *n*-butyric acid and tri(*t*-butyl)phosphine by a variation of Lewis' classical method [1]. The exceptional distortion from the idealized *pseudo*-octahedral coordination geometry in this complex is presumably due to steric effects of the six *t*-butyl substituents interfering with the two propyl chains

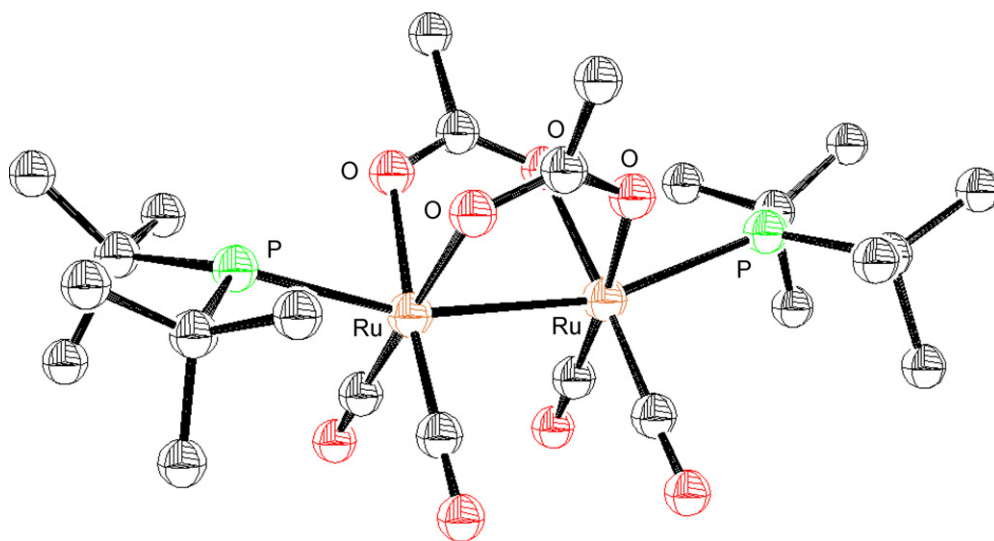

Fig. 2. Molecular structure of $\text{Ru}_2(\text{CO})_4(\text{OOCMe})_2(\text{PBu}^t_2\text{H})_2$ [3].

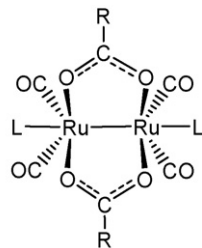
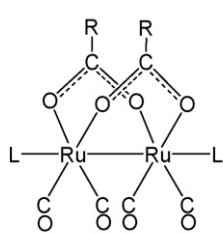

Fig. 3. The sawhorse geometry of $\text{Ru}_2(\text{CO})_4(\text{OOCR})_2\text{L}_2$ complexes (2 perspectives).

(Fig. 1). The molecular structure of the less bulky acetato complex $\text{Ru}_2(\text{CO})_4(\text{OOCMe})_2(\text{PBu}^t_2\text{H})_2$ (as di(*t*-butyl)phosphine derivative), solved by Jones and co-workers in 1988 [3], shows indeed a much less distorted coordination geometry (Fig. 2), which is the case for most diruthenium tetracarbonyl complexes of this type.

The molecular structures of $\text{Ru}_2(\text{CO})_4(\text{OOCPr}^n)_2(\text{PBu}^t_3)_2$ [2] and of $\text{Ru}_2(\text{CO})_4(\text{OOCMe})_2(\text{PBu}^t_2\text{H})_2$ [3] are characterized by a dinuclear ruthenium–ruthenium backbone, each ruthenium atom carrying two terminal carbonyl ligands in *cis*-equatorial positions, in such a way that the $\text{Ru}_2(\text{CO})_4$ moiety resembles a sawhorse (Fig. 3). This $\text{Ru}_2(\text{CO})_4$ sawhorse unit carries two μ^2 - η^2 -O,O carboxylato bridges coordinated in the remaining four equatorial positions and two phosphine ligands sitting in the axial position of the two ruthenium atoms. The two ruthenium atoms show a *pseudo*-octahedral coordination geometry, one coordination position being the other ruthenium atom. The Ru–Ru distance being 2.728(1) [2] or 2.735(1) Å [3] is in accordance with a metal–metal single bond, as suggested by the electron count of 34, the noble-gas rule requiring indeed $18 + 18 - 2 = 34$ electrons for a metal–metal bonded dinuclear complex, the formal oxidation state of ruthenium being +1.

The molecular structure of the labile solvent complexes $\text{Ru}_2(\text{CO})_4(\text{OOCR})_2\text{L}_2$ (L = tetrahydrofuran, acetonitrile, and pyridine), supposed to be similar to that of the isolated phosphine complexes, could also be confirmed by X-ray structure analysis. Bruce et al. isolated the acetonitrile complex $\text{Ru}_2(\text{CO})_4(\text{OOCF}_3)_2(\text{NCMe})_2$ in a crystalline form; the single crystal X-ray structure analysis revealed indeed the expected sawhorse structure [4] (Fig. 4). The

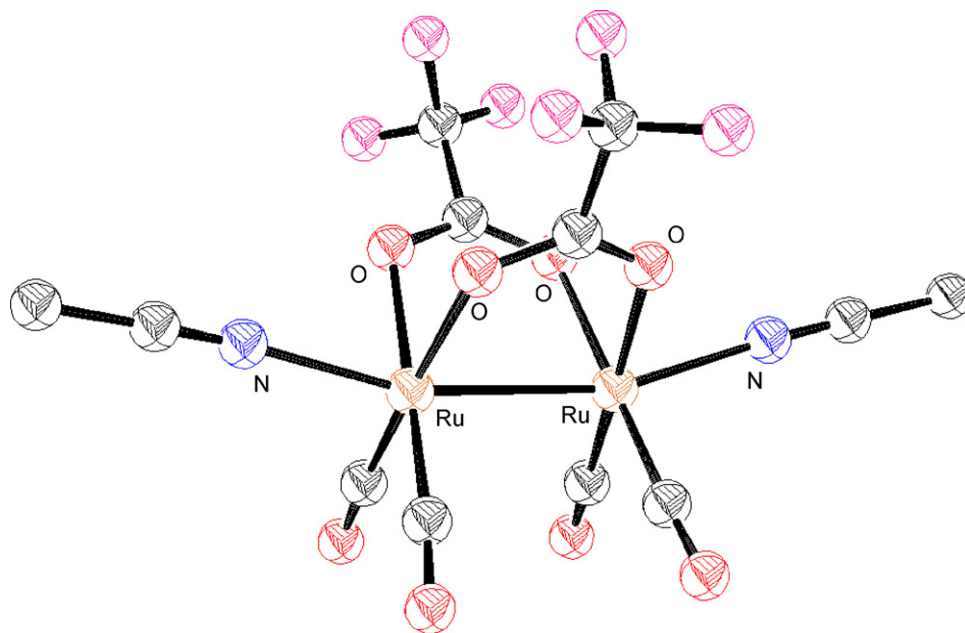

Fig. 4. Molecular structure of $\text{Ru}_2(\text{CO})_4(\text{OOCF}_3)_2(\text{NCMe})_2$ [4].

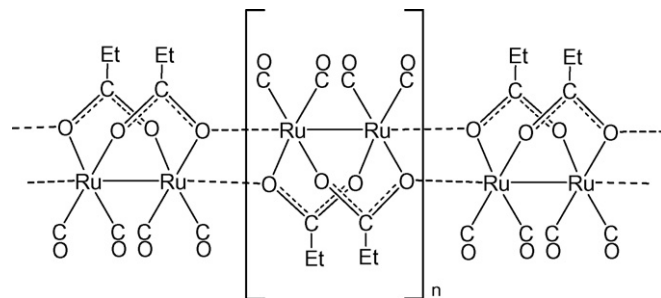

Fig. 5. The chain of sawhorse units in $[\text{Ru}_2(\text{CO})_4(\text{OOCR})_2]_n$ polymers.

pyridine complex $\text{Ru}_2(\text{CO})_4(\text{OOCPh})_2(\text{py})_2$ was crystallized by Xu and Sasaki and shown to have a sawhorse structure [5].

As far as the structure of the polymers originally reported as $[\text{Ru}(\text{CO})_2(\text{OOCR})]_n$ [1] is concerned, we could show in 1985 by combined infrared and Raman spectroscopic analysis of the propionato derivative (R = Et) that these materials are also formed by dinuclear units, held together by strong interactions between an oxygen atom of the carboxylato bridge and a ruthenium atom of the neighboring unit, as shown in Fig. 5. For this reason these polymers are better described as $[\text{Ru}_2(\text{CO})_4(\text{OOCR})_2]_n$, in accordance with Eqs. (1) and (2) [6]. The chain arrangement of the dinuclear units by staggered ruthenium–oxygen interactions was finally confirmed by a single-crystal X-ray structure analyses of the benzoato derivative $[\text{Ru}_2(\text{CO})_4(\text{OOCPh})_2]_n$ [7], similar to the carbonyl-free polymer $[\text{Ru}_2(\text{OOCPh})_5(\text{PhCOOH})]_n$ [8], and of the trifluoroacetato derivative $[\text{Ru}_2(\text{CO})_4(\text{OOCF}_3)_2]_n$ (Fig. 6) [9].

A solid obtained from the reaction of $\text{Ru}_3(\text{CO})_{12}$ with ethylene and water in thf solution, which analyzes to the composition “ $[\text{Ru}(\text{CO})_2(\text{OOCt})]_2 \cdot 0.3 \text{ thf}$ ” was shown by IR and Raman spectroscopy to be an oligomer of $\text{Ru}_2(\text{CO})_4(\text{OOCt})_2$ units linked by ruthenium–oxygen interactions and terminated by thf ligands, see Fig. 7 [6]. Dimers of dinuclear $\text{Ru}_2(\text{CO})_4(\text{OOCR})_2$ units have been isolated and structurally characterized. The single-crystal X-ray structure analyses of $[\text{Ru}_2(\text{CO})_5(\text{OOCF}_3)_2]_2$ [9] and of $[\text{Ru}_2(\text{CO})_4(\text{OOCBu}^s)_2(\text{Bu}^s\text{COOH})]_2$ [10] reveal the two $\text{Ru}_2(\text{CO})_4(\text{OOCR})_2$ sawhorse units to be linked by two

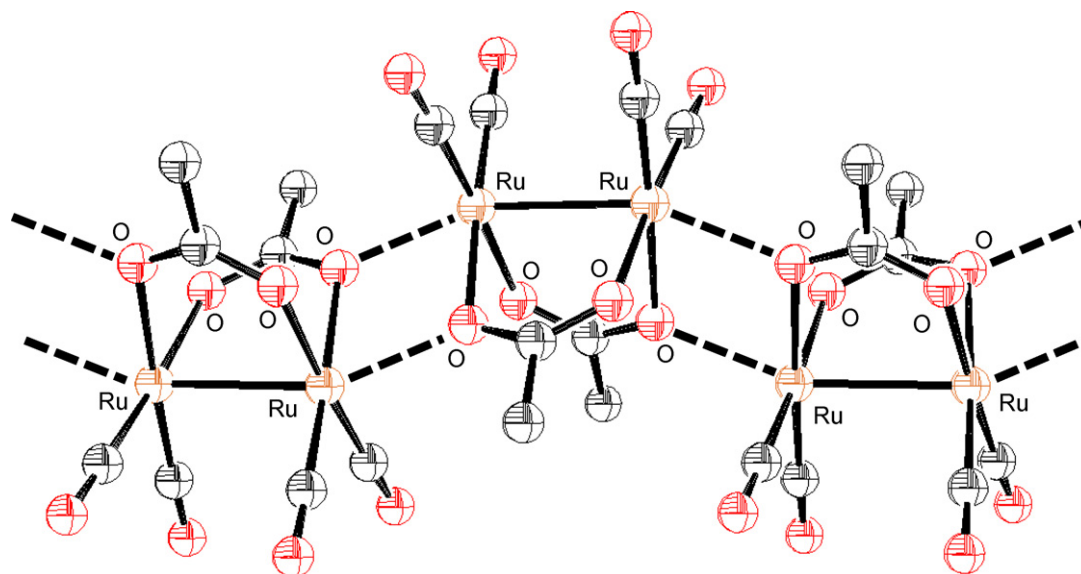

Fig. 6. Structure of a fragment of the polymeric chain in $[\text{Ru}_2(\text{CO})_4(\text{OOCCF}_3)_2]_n$, the fluorine atoms being omitted for clarity [9].

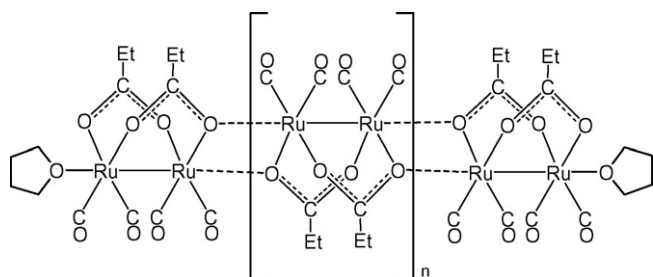

Fig. 7. The chain of sawhorse units in $[\text{Ru}_2(\text{CO})_4(\text{OOCCMe})_2]_2$ oligomers [6].

ruthenium–oxygen bonds, the terminal positions being occupied either by carbonyl or by *sec*-butyric acid ligands, see Fig. 8; the same applies to $[\text{Ru}_2(\text{CO})_4(\text{OOCMe})_2(\text{PBu}_3)]_2$ [11].

The labile axial ligands in $\text{Ru}_2(\text{CO})_4(\text{OOCR})_2\text{L}_2$, formed by dissolving the polymers $[\text{Ru}_2(\text{CO})_4(\text{OOCR})_2]_n$ in coordinating sol-

vents ($\text{L} = \text{tetrahydrofuran, acetonitrile, pyridine}$) can be easily displaced by other two-electron donors such as carbonyls, phosphines and organic sulfides. The bridging carboxylato ligands, on the other hand, can be replaced by other three-electron bridges such as carboxamido, pyrazolato, oxinato, oximato, sulfinato, thiolato, phosphato, phosphinato, phosphinito or phosphido ligands, maintaining the sawhorse geometry of the $\text{Ru}_2(\text{CO})_4$ moiety. The chemistry of complexes of this type is reviewed here covering the literature from 1969 to 2008.

2. Synthetic methods

The classical synthesis of carboxylato-bridged sawhorse-type diruthenium tetracarbonyl complexes, which consists in refluxing $\text{Ru}_3(\text{CO})_{12}$ in a carboxylic acid (neat), has some limitations in as much it depends on the boiling point of the corresponding RCOOH . Thus, with formic, acetic or propionic acid, the reaction produces the polymers $[\text{Ru}_2(\text{CO})_4(\text{OOCR})_2]_n$ ($\text{R} = \text{H, Me, Et}$), which depoly-

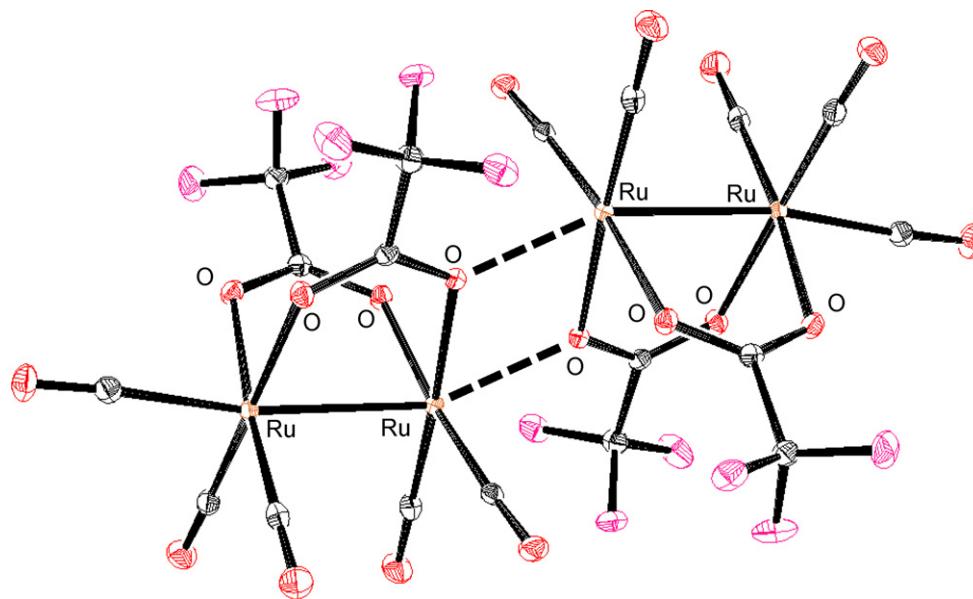
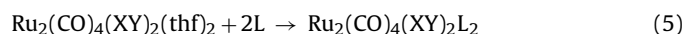
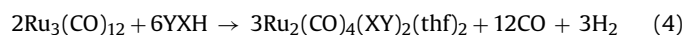

Fig. 8. Molecular structure of the sawhorse dimer $[\text{Ru}_2(\text{CO})_5(\text{OOCCF}_3)_2]_2$ [9].

merize in coordinating solvents L to give the solvent complexes $\text{Ru}_2(\text{CO})_4(\text{OOCR})_2\text{L}_2$ (L = thf, MeCN) that can be converted into the stable phosphine complexes $\text{Ru}_2(\text{CO})_4(\text{OOCR})_2(\text{PR}'_3)_2$ according to Eqs. (1)–(3), or into other stable derivatives.

For the reaction with the solid benzoic acid, Strähle and co-workers performed the reaction in molten PhCOOH at 130 °C to obtain the polymeric $[\text{Ru}_2(\text{CO})_4(\text{OOCPh})_2]_n$ in quantitative yield; at 165 °C the reaction gives, in smaller yields, the dinuclear hexacarbonyl decomposition product $\text{Ru}_2(\text{CO})_6(\text{OOCPh})_2$ [8]. If the reaction with benzoic acid is carried out at 145 °C in toluene solution in a glass-lined autoclave, the main product is the isostructural complex $\text{Ru}_2(\text{CO})_4(\text{OOCPh})_2(\text{HOOCPh})_2$, in which the two axial positions are occupied by benzoic acid molecules coordinated as two-electron ligands through the oxo function [10].

For the reaction with the high-boiling decanoic acid, Lewis and co-workers were already using refluxing benzene as a solvent [1]. Schumann et al. used refluxing *n*-butanol as a solvent for the synthesis of $\text{Ru}_2(\text{CO})_4(\text{OOCPr}^n)_2(\text{PBU}^t_3)_2$ [2], Jones and co-workers synthesized $\text{Ru}_2(\text{CO})_4(\text{OOCMe})_2(\text{PBU}^t_2\text{H})_2$ in refluxing di-*n*-butyl ether [3]



A more generally applicable variant of the original thermal method [1] consists in using tetrahydrofuran (thf) as solvent and performing the reaction at 120 °C in a pressure Schlenk tube. In this case, the labile thf complexes are formed as intermediates that react with suitable two-electron ligands to give the corresponding dinuclear sawhorse complexes, according to Eqs. (4) and (5). By this method not only a large variety of carboxylato complexes of the type $\text{Ru}_2(\text{CO})_4(\text{OOCR})_2\text{L}_2$ became accessible (XYH = RCOOH) [12–15], but also carboxamido complexes (XYH = RCONH₂) [16,17], pyrazolato complexes (XYH = C₃R₁R₂R₃N₂H) [18,19], oxinato complexes (XYH = R₁R₂CNOH) [20] and sulfonato complexes (XYH = R₂SO₃H) [21], all with the typical $\text{Ru}_2(\text{CO})_4$ sawhorse structure.

The only drawback of this method is that, for high-temperature reactions (120 °C) in tetrahydrofuran (b.p. 66 °C), a pressure Schlenk tube or an autoclave is required, not always readily available in syn-

thetic laboratories. This problem can be overcome by the use of methanol instead of thf as solvent, which requires only reflux conditions. We observed recently that for most carboxylato complexes the yields of the reaction in refluxing methanol are almost identical to those of the high-temperature reaction in thf (pressure Schlenk tube) [22,23].

Phosphine-containing diruthenium tetracarbonyl carboxylato complexes have also been synthesized from tetranuclear precursors. Thus, $\text{Ru}_2(\text{CO})_4(\text{OOCMe})_2(\text{PBU}_3)_2$ has been obtained from the reaction of $\text{H}_4\text{Ru}_4(\text{CO})_8(\text{PBU}_3)_4$ and acetic acid under hydrogen pressure [24].

An alternative synthesis of diruthenium tetracarbonyl carboxylato complexes said to be facile and benign was reported by Spiccia and co-workers [25]. The reaction of the polymer $[\text{Ru}(\text{CO})_2\text{Cl}_2]_n$, readily available from $\text{RuCl}_3 \cdot n\text{H}_2\text{O}$ in refluxing formic acid [26], with the corresponding sodium carboxylate and a two-electron ligand such as pyridine (py) in refluxing methanol produces directly the corresponding pyridine complexes $\text{Ru}_2(\text{CO})_4(\text{OOCR})_2(\text{py})_2$ according to Eq. (6), the yields, however, being not higher than those obtained from $\text{Ru}_3(\text{CO})_{12}$.

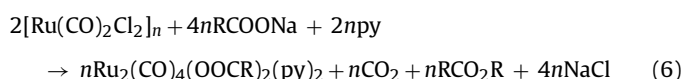

It is also possible to convert $\text{Ru}_2(\text{CO})_4$ complexes into other $\text{Ru}_2(\text{CO})_4$ complexes. Accordingly, Haines and co-workers reported the use of the polymeric carboxylato complexes $[\text{Ru}_2(\text{CO})_4(\text{OOCR})_2]_n$ as synthons for pyridyl-, quinolyl- or bipyridyl-phosphine derivatives [27].

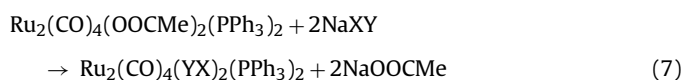

On the other hand, the pyrazolato complexes $\text{Ru}_2(\text{CO})_4(\text{YX})_2\text{L}_2$ (XYH = C₃R₁R₂R₃N₂H, L = CO) react with a tenfold quantity of formic, acetic, propionic or trifluoroacetic acid to give the carboxylato complexes $\text{Ru}_2(\text{CO})_4(\text{OOCR})_2(\text{YXH})_2$, the outgoing pyrazolato

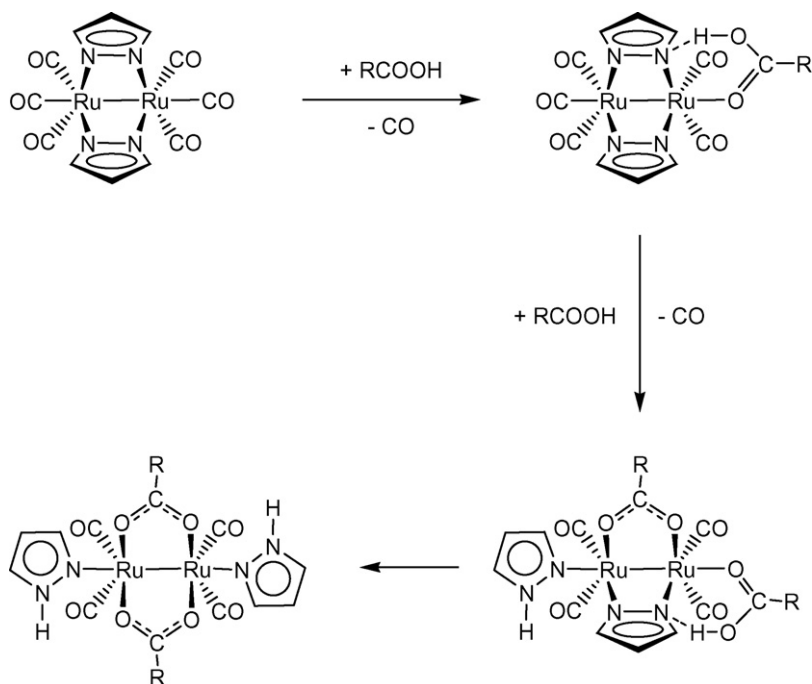

Scheme 1. Substitution of bridging pyrazolato ligands by carboxylato bridges [28].

bridges (YX) being caught as terminal pyrazol ligands (YXH), according to Eq. (8) [19]. The replacement of the three-electron bridging ligands $\eta^2\text{-}\mu_2\text{-YX}$ in $\text{Ru}_2(\text{CO})_4(\text{YX})_2\text{L}_2$ by other three-electron bridges such as $\eta^2\text{-}\mu_2\text{-RCOO}$ by reacting with RCOOH works the better the higher the acidity of RCOOH is and the more basic the $\eta^2\text{-}\mu_2\text{-YX}$ bridges are. This is suggestive of a mechanism which starts with the entering of RCOOH into a terminal position (replacing L), proton transfer from the $\eta^1\text{-}\mu_1\text{-RCOOH}$ ligand to a $\eta^2\text{-}\mu_2\text{-YX}$ bridge that will move as $\eta^1\text{-}\mu_1\text{-YXH}$ ligand into a terminal position, see Scheme 1 [28].

The final carboxylato complexes containing two terminal pyrazol ligands could be isolated and unambiguously characterized [19], the proposed intermediacy of pyrazolato complexes with terminal carboxylic acid ligands [28] is consistent with the observation of Shvo and co-workers, who isolated and crystallographically characterized the complex $\text{Ru}_2(\text{CO})_4(\text{OOCPh})_2(\text{HOOCPh})_2$, in which two benzoic acid ligands are terminally coordinated via the oxo function, while the OH function forms an internal hydrogen bond to an oxygen atom of a benzoato bridge [10].

3. Carboxylato and carboxamido derivatives

The most important access to carboxylato-bridged $\text{Ru}_2(\text{CO})_4$ sawhorse-type complexes still is Lewis' classical method [1] of refluxing $\text{Ru}_3(\text{CO})_{12}$ in the appropriate carboxylic acid, according to Eqs. (1)–(3), or variations thereof [2,3,5,22,23].

The interrelationships of various diruthenium tetracarbonyl complexes formed upon reaction of $\text{Ru}_3(\text{CO})_{12}$ with various carboxylic acids RCOOH have been studied very carefully by Shvo and co-workers [29]. The complexes formed depend on the substituent R, the molar ratio of the reactants and on whether or not the reaction is carried out in an open or closed vessel; the results are summarized in Scheme 2.

The most important alternative is the substitution of $\mu^2\text{-}\eta^2\text{-YX}$ three-electron ligands in $\text{Ru}_2(\text{CO})_4(\text{YX})_2\text{L}_2$ complexes by $\mu^2\text{-}\eta^2\text{-OOCR}$ bridges according to Eq. (8) [19], although some other possibilities have been reported. Lewis et al. found that the phosphine complexes $\text{Ru}_2(\text{CO})_4(\text{OOCR})_2(\text{PPh}_3)_2$ are also accessible from the reaction of the mononuclear complex $\text{Ru}(\text{CO})_4(\text{PPh}_3)$ or the

Table 1
Infrared data of isolated and fully characterized dinuclear bis-carboxylato diruthenium tetracarbonyl sawhorse complexes.

Complex	$\nu(\text{CO})$ (cm^{-1})	Medium	Refs.
$\text{Ru}_2(\text{CO})_4(\text{OOCCH}_3)_2[\text{P}(p\text{-C}_6\text{H}_5\text{F}_3)_2]$	2034vs, 1991m, 1965vs, 1935w	CCl_4	[1]
$\text{Ru}_2(\text{CO})_4(\text{OOCCH}_3)_2(\text{PBu}^t)_3$	2017vs, 1969m, 1937vs, 1907s	CH_2Cl_2	[43]
$\text{Ru}_2(\text{CO})_4(\text{OOCCH}_3)_2(\text{NC}_5\text{H}_4\text{-}p\text{-OC}_{10}\text{H}_{21})_2$	2025vs, 1973m, 1943vs	$\text{C}_4\text{H}_8\text{O}$	[13]
$\text{Ru}_2(\text{CO})_4(\text{OOCMe})_2(\text{NCMe})_2$	2040vs, 1988m, 1957vs, 1924w	CHCl_3	[1]
$\text{Ru}_2(\text{CO})_4(\text{OOCMe})_2(\text{py})_2$	2030vs, 1979m, 1948vs	CCl_4	[1]
$\text{Ru}_2(\text{CO})_6(\text{OOCMe})_2$	2106m, 2098w, 2082vs, 2038s, 2008vs, 1944w	C_6H_{12}	[1]
$\text{Ru}_2(\text{CO})_4(\text{OOCMe})_2(\text{PBu}^n)_3$	2019vs, 2011sh, 1972s, 1965sh, 1947vs, 1936w	C_6H_{12}	[1]
$\text{Ru}_2(\text{CO})_4(\text{OOCMe})_2(\text{PBu}^n)_3$	2028vs, 2015vw, 1972vs, 1944w	C_6D_{12}	[44]
$\text{Ru}_2(\text{CO})_5(\text{OOCMe})_2(\text{PBu}^n)_3$ 1979vs, 1958w, 1941m	2072s, 2059sh, 2035w, 2018vs, 2005sh, 1990sh,	C_6D_{12}	[44]
$\text{Ru}_2(\text{CO})_4(\text{OOCMe})_2(\text{PBu}^n)_3$	2016vs, 1966m, 1932vs, 1901s	CH_2Cl_2	[43]
$\text{Ru}_2(\text{CO})_4(\text{OOCMe})_2(\text{PBu}^t)_2\text{H}_2$	2019vs, 1965s, 1936vs, 1907m	nujol	[3]
$\text{Ru}_2(\text{CO})_4(\text{OOCMe})_2[\text{P}(p\text{-C}_6\text{H}_5\text{F}_3)_2]$	2031vs, 1986m, 1962vs	C_6H_{12}	[1]
$\text{Ru}_2(\text{CO})_4(\text{OOCMe})_2(\text{PPh}_3)_2$	2028vs, 1985m, 1960sh, 1959vs, 1929w	CCl_4	[1]
$\text{Ru}_2(\text{CO})_4(\text{OOCMe})_2(\text{NC}_5\text{H}_4\text{-}p\text{-OC}_{10}\text{H}_{21})_2$	2021vs, 1969m, 1938vs	$\text{C}_4\text{H}_8\text{O}$	[13]
$\text{Ru}_2(\text{CO})_4(\text{OOCMe})_2(\text{diop})$	2023vs, 1978m, 1949vs	CHCl_3	[33]
$\text{Ru}_2(\text{CO})_4(\text{OOCMe})_2(\text{NCMe})_2$	2030vs, 1978m, 1945vs	$\text{C}_4\text{H}_8\text{O}$	[6]
$\text{Ru}_2(\text{CO})_4(\text{OOCMe})_2(\text{AsPh}_3)_2$	2030vs, 1988m, 1959vs	CCl_4	[1]
$\text{Ru}_2(\text{CO})_4(\text{OOCMe})_2(\text{PPh}_3)_2$	2028vs, 1984m, 1957vs, 1944w	CCl_4	[1]
$\text{Ru}_2(\text{CO})_4(\text{OOCMe})_2(\text{PBu}^n)_3$	2021vs, 1975m, 1945vs, 1917m	CH_2Cl_2	[43]
$\text{Ru}_2(\text{CO})_4(\text{OOCMe})_2[\text{P}(p\text{-C}_6\text{H}_5\text{F}_3)_2]$	2029vs, 1986m, 1960vs, 1946w	CCl_4	[1]
$\text{Ru}_2(\text{CO})_4(\text{OOCMe})_2(\text{diop})$	2022vs, 1976m, 1947vs	CHCl_3	[33]
$\text{Ru}_2(\text{CO})_4(\text{OOCPr}^n)_2(\text{PBu}^n)_3$	2016vs, 1965s, 1933vs	KBr	[2]
$\text{Ru}_2(\text{CO})_4(\text{OOCBu}^t)_2(\text{PPh}_3)_2$	2013s, 1969m, 1942s	CaF_2	[17]
$\text{Ru}_2(\text{CO})_6(\text{OOCPh})_2$	2091vs, 1976s, 1947vs, 1917s	CH_2Cl_2	[7]
$\text{Ru}_2(\text{CO})_4(\text{OOCPh})_2(\text{py})_2$	2000, 1960, 1940, 1910 (int. n. g.)	KBr	[5]
$\text{Ru}_2(\text{CO})_4(\text{OOCPh})_2(\text{NC}_5\text{H}_4\text{-}p\text{-OC}_{10}\text{H}_{21})_2$	2023vs, 1971m, 1941vs	$\text{C}_4\text{H}_8\text{O}$	[13]
$\text{Ru}_2(\text{CO})_4(\text{OOC}_9\text{H}_{19})_2(\text{AsPh}_3)_2$	2020vs, 1987m, 1960vs, 1950w	C_6H_{14}	[1]
$\text{Ru}_2(\text{CO})_4(\text{OOC}_{17}\text{H}_{35})_2(\text{PBu}^n)_3$	2012vs, 1964s, 1930vs, 1897m	CH_2Cl_2	[43]
$\text{Ru}_2(\text{CO})_4(\text{OOCF}_3)_2(\text{NCMe})_2$	2047vs, 2000m, 1970s	CH_2Cl_2	[4]
$\text{Ru}_2(\text{CO})_6(\text{OOCF}_3)_2$	2053s, 2013s, 1996s, 1968s	KBr	[9]
$\text{Ru}_2(\text{CO})_4(\text{OOCF}_3)_2(\text{NC}_5\text{H}_4\text{-}p\text{-OC}_{10}\text{H}_{21})_2$	2037vs, 1986m, 1958vs	$\text{C}_4\text{H}_8\text{O}$	[13]
$\text{Ru}_2(\text{CO})_4[\text{OOCPh}(\text{OMe})\text{CF}_3]_2(\text{NCMe})_2$	2044vs, 1993m, 1963vs	CH_2Cl_2	[15]
$\text{Ru}_2(\text{CO})_4[\text{OOCPh}(\text{OH})\text{H}]_2(\text{NCMe})_2$	2042vs, 1992m, 1961vs	CH_2Cl_2	[15]
$\text{Ru}_2(\text{CO})_4[\text{OOCPh}(\text{OH})\text{H}]_2(\text{PPh}_3)_2$	2028vs, 1984m, 1957vs	CH_2Cl_2	[15]
$\text{Ru}_2(\text{CO})_4(\text{OOCCH}_3)_2(\text{N}_2\text{C}_3\text{H}_4)_2$	2034vs, 1982m, 1951vs	CH_2Cl_2	[19]
$\text{Ru}_2(\text{CO})_4(\text{OOCMe})_2(\text{N}_2\text{C}_3\text{H}_4)_2$	2030vs, 1977m, 1945vs	CH_2Cl_2	[19]
$\text{Ru}_2(\text{CO})_4(\text{OOCMe})_2(\text{N}_2\text{C}_3\text{H}_4)_2$	2029vs, 1977m, 1944vs	CH_2Cl_2	[19]
$\text{Ru}_2(\text{CO})_4(\text{OOCF}_3)_2(\text{N}_2\text{C}_3\text{H}_4)_2$	2044vs, 1993m, 1964vs	CH_2Cl_2	[19]
$\text{Ru}_2(\text{CO})_4(\text{OOC}_5\text{H}_4\text{FeCp})_2(\text{PPh}_3)_2$	2022vs, 1977m, 1951vs	$\text{C}_4\text{H}_8\text{O}$	[38]
$\text{Ru}_2(\text{CO})_4(\text{OOC}_5\text{H}_4\text{FeCp})_2(\text{py})_2$	2021vs, 1969m, 1938vs	$\text{C}_4\text{H}_8\text{O}$	[38]
$\text{Ru}_2(\text{CO})_4(\text{OOC}(\text{CH}_2)_3\text{Ph})_2(\text{PPh}_3)_2$	2023vs, 1971m, 1938vs	CH_2Cl_2	[23]
$\text{Ru}_2(\text{CO})_4(\text{OOC}(\text{CH}_2)_3\text{Ph})_2(\text{py})_2$	2080vs, 2065m, 2022vs, 1977m, 1949s	CH_2Cl_2	[23]
$\text{Ru}_2(\text{CO})_4(\text{OOC}_6\text{H}_4\text{-}p\text{-OC}_{10}\text{H}_{21})_2(\text{py})_2$	2023vs, 1972m, 1941vs	$\text{C}_4\text{H}_8\text{O}$	[13]
$\text{Ru}_2(\text{CO})_4(\text{OOCdend})_2(\text{py})_2$	2027vs, 1976m, 1944vs	KBr	[14]
$\text{Ru}_2(\text{CO})_4(\text{OOCdend})_2(\text{PPh}_3)_2$	2024vs, 1981m, 1952vs	KBr	[14]
$[\text{Ru}_2(\text{CO})_4(\text{OOCMe})_2(\text{PBu}^n)]_2$	2039m, 2027vs, 1981s, 1960vs, 1938vw, 1919m, 1894vw	C_6D_{12}	[11]
$\text{Ru}_4(\text{CO})_8[\text{OOC}(\text{CH}_2)_3\text{COO}]_2(\text{PBu}^n)_4$	2100vw, 2038vs, 1992vs, 1974vs, 1947vs, 1905sh	KBr	[11]
$\text{Ru}_4(\text{CO})_8[\text{OOC}(\text{CH}_2)_3\text{COO}]_2(\text{diop})_3$	2060vw, 1990vs, 1925vs, 1895s	KBr	[45]

Abbreviations: Me = CH_3 , Et = CH_2CH_3 , Prⁿ = $\text{CH}_2\text{CH}_2\text{CH}_3$, Buⁿ = $\text{CH}_2\text{CH}_2\text{CH}_2\text{CH}_3$, Bu^t = $\text{C}(\text{CH}_3)_3$, Ph = C_6H_5 , Cp = C_5H_5 , py = NC_5H_5 , diop = $\text{Ph}_2\text{P-CH}_2\text{-C}_5\text{H}_8\text{O-CH}_2\text{-PPh}_2$, dend = $p\text{-C}_6\text{H}_4\text{-CO}_2\text{-(CH}_2\text{)}_{10}\text{-O-}p\text{-C}_6\text{H}_4\text{-CO}_2\text{-sym-C}_6\text{H}_3(\text{CO}_2\text{-(CH}_2\text{)}_{10}\text{-O-}p\text{-C}_6\text{H}_4\text{-CO}_2\text{-}p\text{-C}_6\text{H}_4\text{-}p\text{-C}_6\text{H}_4\text{-CN})_2$.

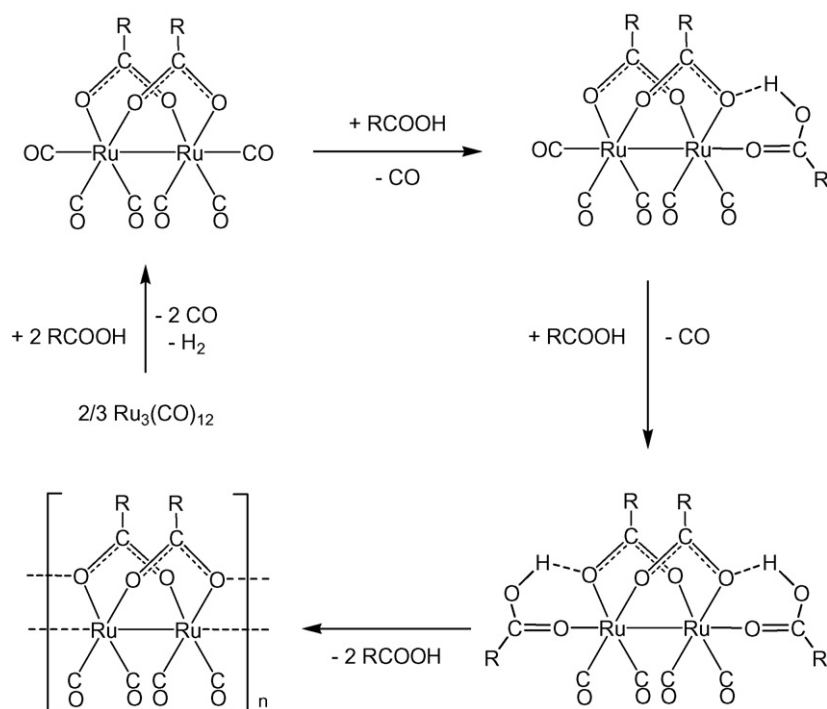

Scheme 2. Steps in the reaction of ruthenium carbonyl with carboxylic acids [29].

trinuclear complex $\text{Ru}_3(\text{CO})_9(\text{PPh}_3)_3$ with the corresponding carboxylic acid [30]. In 1985, we observed that the propionato derivatives $\text{Ru}_2(\text{CO})_4(\text{OOCeEt})_2(\text{thf})_2$ and $\text{Ru}_2(\text{CO})_4(\text{OOCeEt})_2(\text{NCMe})_2$ are also accessible from the reaction of $\text{Ru}_3(\text{CO})_{12}$ with ethylene and water [6].

The isolated and fully characterized dinuclear dicarboxylato diruthenium tetracarbonyl sawhorse complexes are compiled in Table 1 together with the infrared data in the carbonyl region. The $\text{Ru}_2(\text{CO})_4$ sawhorse moiety can be easily recognized by a characteristic three band pattern (very strong–medium–very strong) between 2100 and 1900 cm^{-1} , unless there are distortions that cause additional weak $\nu(\text{CO})$ absorptions. The two carboxylato bridges give rise to two $\nu(\text{OCO})$ absorptions between 1550 and 1400 cm^{-1} that correspond to the asymmetrical and the symmetrical stretching frequencies of the three-atom oscillators. A typical infrared spectrum of $\text{Ru}_2(\text{CO})_4(\text{OOCeR})_2\text{L}_2$ complexes is shown in Fig. 9.

Sometimes the additional terminal ligands (e.g. pyrazine) have frequencies at around 790 cm^{-1} the overtone of which (1580 cm^{-1}) is close enough with respect to the asymmetric $\nu(\text{OCO})$ stretch to come into Fermi resonance with this vibration, so that this band may gain in intensity. If the two terminal ligands are carbonyl ligands, the resulting $\text{Ru}_2(\text{CO})_6$ moiety does of course no longer show the characteristic three-band $\nu(\text{CO})$ pattern in the infrared spectrum.

The nature of carboxylato-bridged diruthenium tetracarbonyl complexes containing diphosphine ligands (Scheme 3) as well as diarsine, arsinophosphine or dithioether ligands still remains a debatable point: The optically active complexes $\text{Ru}_2(\text{CO})_4(\text{OOCeR})_2(\text{diop})$, R being $\text{CH}(\text{Me})\text{Et}$, $\text{CMe}=\text{CHMe}$, have been reported to be polymers $[\text{Ru}_2(\text{CO})_4(\text{OOCeR})_2(\text{diop})]_n$ containing diphosphine bridges between the sawhorse units because of the low solubility of these materials [31]. The low solubility argument was also used for the diphosphine complexes $[\text{Ru}_2(\text{CO})_4(\text{OOCeR})_2(\text{diphos})]_n$ (R = Me, Et, diphos = dpmp, dmpm) considered to be polymers (Fig. 10) [32]. On the other hand, $\text{Ru}_2(\text{CO})_4[\text{OOCePh}(\text{OMe})\text{CF}_3]_2(\text{diphos})$ and

$\text{Ru}_2(\text{CO})_4[\text{OOCePh}(\text{OEt})\text{H}]_2(\text{diphos})$ with diphos = dppe, diop or cyclop [15] as well as $\text{Ru}_2(\text{CO})_4(\text{OOCeR})_2(\text{diop})$ with R = Me, Et, CF_3 [33] have been reported to be in all likelihood dinuclear complexes with $\eta^2\text{-}\mu_2$ -diphosphine ligands, because of their good solubility in chloroform or dichloromethane (Fig. 10). In the case of the dithioether derivative $[\text{Ru}_2(\text{CO})_4(\text{OOCeMe})_2(\text{Me}_2\text{SCH}_2\text{SMe}_2)]_n$, a single-crystal X-ray structure analysis revealed indeed the polymeric nature of this compound [34]; it is however not certain if this applies to all bidentate ligands.

The reactivity of carboxylato-bridged diruthenium tetracarbonyl complexes towards aromatic diimes (N \cap N) is of particular interest, since it leads to ionic compounds. Thus, the thermal

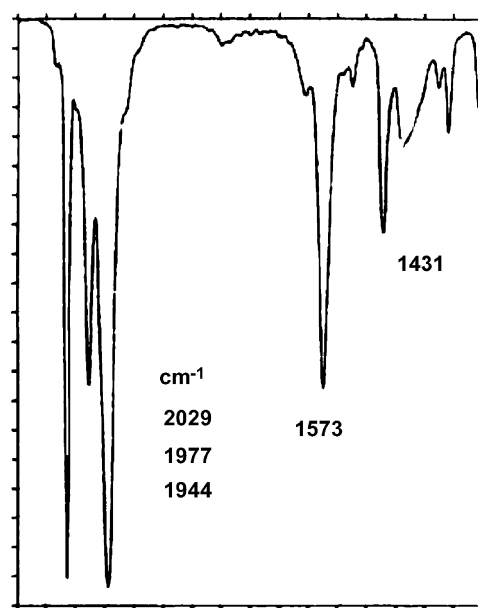
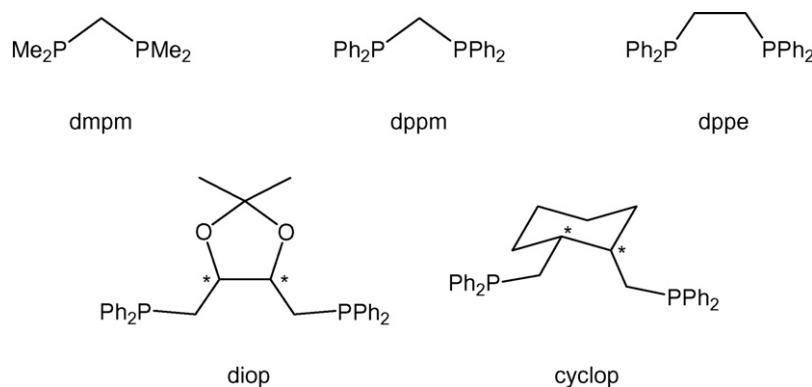

Fig. 9. Infrared spectrum of $\text{Ru}_2(\text{CO})_4(\text{OOCeEt})_2(\text{N}_2\text{C}_3\text{H}_4)_2$ in CH_2Cl_2 [19].



Scheme 3. Schematic representations of non-chiral and chiral diphosphine (diphos) ligands of the type $R_2P \cap PR_2$.

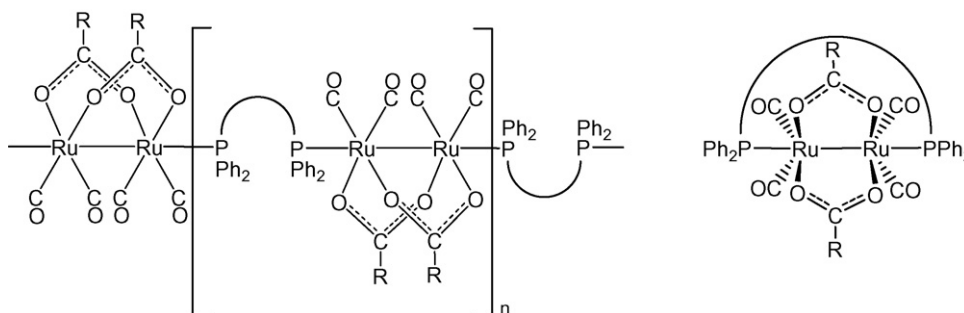
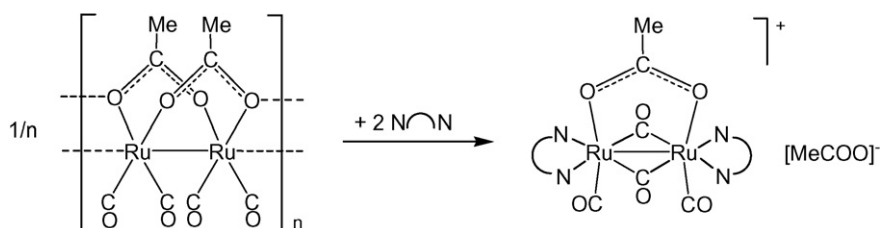
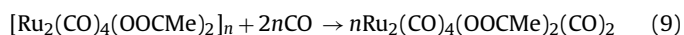

Fig. 10. Polymeric [31,32,34] and monomeric [15,33] structures proposed for diphosphine sawhorse complexes of the type $Ru_2(CO)_4(OOCCR)_2(diphos)$.

reaction of the polymer $[Ru_2(CO)_4(OOCMe)_2]_n$ with 2,2'-bipyridine, 1,10-phenanthroline or dimethyl derivatives thereof yields the acetate salts $[Ru_2(CO)_4(OOCMe)(N \cap N)_2][MeCOO]$ [35] (Scheme 4); the analogous reaction was observed with 1,1'-biisoquinoline [36]. The reaction works even better with the dinuclear pyridine derivatives $Ru_2(CO)_4(OOCR)_2(py)_2$, leading to the benzoato-bridged cations ($R = Ph$) [37] and the ferrocene-carboxylato-bridged cations ($R = C_5H_4FeCp$) [38].

The decomposition of carboxylato-bridged diruthenium tetracarbonyl complexes with carbon monoxide and hydrogen has been studied in detail by Frediani et al. Thus, a suspension of the polymeric $[Ru_2(CO)_4(OOCMe)_2]_n$ in *n*-heptane under CO pressure (50 bar) at room temperature leads to dissolution with formation of $Ru_2(CO)_6(OOCMe)_2$. This solution remains unchanged below 100 °C; above this temperature, the system evolves to give the ruthenium carbonyls $Ru(CO)_5$ and $Ru_3(CO)_{12}$ as well as free acetic acid, in particular if hydrogen is added (total pressure 100 bar), according to Eqs. (9) and (10). Acetic acid is formed even in the absence of hydrogen; in this case heptenes are detected in the solution, suggesting *n*-heptane to be the hydrogen source [39].



Scheme 4. Reactivity of polymeric carboxylato-bridged diruthenium tetracarbonyl complexes towards aromatic diimes ($N \cap N$) [35–38].

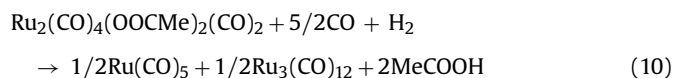

The decomposition of the phosphine derivative $Ru_2(CO)_4(OOCMe)_2(PPh_3)_2$ under hydrogen pressure (100 bar) at 80 °C leads, in the absence [40] or in the presence [41] of base, to mono- or tetranuclear hydrido complexes, presumably via a dinuclear intermediate, according to Eqs. (11)–(15). In all cases acetic acid is liberated

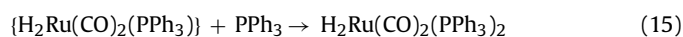
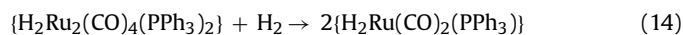
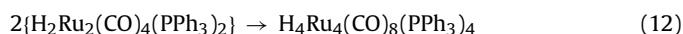
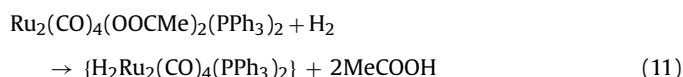

On the other hand, it could be shown that the dinuclear biscarboxylato complex $Ru_2(CO)_4(OOCMe)_2(PBu^t)_2$ reacts with acetic acid in *n*-heptane at 40 °C to give quantitatively the mononuclear complex $Ru(CO)_2(OOCMe)_2(PBu^t)_3$ and molecular

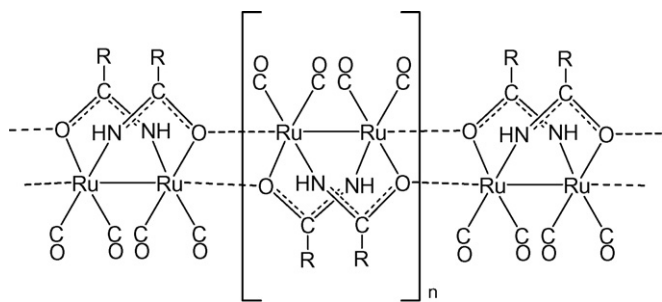
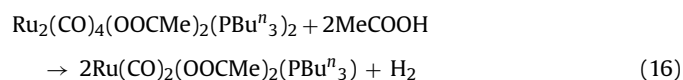

Fig. 11. Proposed structure for the polymers $[\text{Ru}_2(\text{CO})_4(\text{OHCR})_2]_n$, the connection between the sawhorse units being assured by Ru–O interactions [16].

hydrogen according to Eq. (16); the unstable mononuclear product seems to contain one η^2 -acetato and one η^1 -acetato ligand [42]



The carboxamido or carbamoylato diruthenium tetracarbonyl complexes contain two μ^2 - η^2 -ONHCR bridges derived from carboxylic amides. Complexes of this type are accessible from the reaction of $\text{Ru}_3(\text{CO})_{12}$ with RCONH_2 in refluxing tetrahydrofuran. The thf complexes formed as primary products according to Eq. (4) are, however, not stable and give the polymers $[\text{Ru}_2(\text{CO})_4(\text{ONHCR})_2]_n$ ($\text{R} = \text{Me}, \text{Et}, \text{Pr}^i, \text{Ph}$) that precipitate from thf. They are only soluble in strongly coordinating solvents such as acetonitrile or dimethylsulfoxide or in the presence of donor molecules such as phosphines.

The dinuclear complexes $\text{Ru}_2(\text{CO})_4(\text{ONHCR})_2\text{L}_2$ ($\text{R} = \text{Me}, \text{L} = \text{Me}_2\text{SO}, \text{PPh}_3$; $\text{R} = \text{Et}, \text{L} = \text{Me}_2\text{SO}$; $\text{R} = \text{Pr}^i, \text{L} = \text{Me}_2\text{SO}$; $\text{R} = \text{Ph}, \text{L} = \text{Me}_2\text{SO}, \text{MeCN}$) have been isolated according to Eq. (5) and characterized [16]. As the single-crystal X-ray structure analyses of $\text{Ru}_2(\text{CO})_4(\text{ONHCR})_2(\text{NCMe})_2$ [16] and of $\text{Ru}_2(\text{CO})_4(\text{ONHCR})_2(\text{PPh}_3)_2$ [17] reveal a *trans*-arrangement of the two μ^2 - η^2 -carboxamido bridges with respect to each other, this arrangement has also been proposed for the polymers $[\text{Ru}_2(\text{CO})_4(\text{ONHCR})_2]_n$ (Fig. 11) in accordance with the infrared data [16].

4. Pyrazolato, amido, triazenido, pyridinato, pyridonato, oximato and thiazolato derivatives

The five-membered heterocycle pyrazole, $\text{C}_3\text{H}_4\text{N}_2$, and its derivatives $\text{C}_3\text{HR}^1\text{R}^2\text{R}^3\text{N}_2$ (pzH) are N–H acidic and react with ruthenium carbonyl in a similar way as carboxylic acids. Thus, Oro and co-workers obtained the bispyrazolato complexes $\text{Ru}_2(\text{CO})_6(\text{pz})_2$ (pzH = pyrazole, 2-methylpyrazole, 2,4-dimethylpyrazole, indazole), by reacting the relevant pyrazole pzH with $\text{RuCl}_3 \cdot n\text{H}_2\text{O}$ in refluxing 2-methoxyethanol, followed by treatment of the solution with metallic zinc under carbon monoxide gas [46].

Later on, it was found that $\text{Ru}_2(\text{CO})_6(\text{pz})_2$ complexes are also accessible by thermal reaction of $\text{Ru}_3(\text{CO})_{12}$ with pzH according to Eqs. (4) and (5) [19]. Alternatively, the pyrazolato complex $\text{Ru}_2(\text{CO})_4(\text{pz})_2(\text{PPh}_3)_2$ has been synthesized from the reaction of the acetato complex $\text{Ru}_2(\text{CO})_4(\text{OOCMe})_2(\text{PPh}_3)_2$ with sodium pyrazolate, according to Eq. (7) [47]. On the other hand, the pyrazolato complexes $\text{Ru}_2(\text{CO})_6(\text{pz})_2$ were found to react with carboxylic acid to give the corresponding carboxylato derivatives (Scheme 1) [19,28].

It is noteworthy that, in contrast to the carboxylato derivatives that undergo spontaneous decarbonylation to give the corresponding polymers $[\text{Ru}_2(\text{CO})_4(\text{OOCMe})_2]_n$, the pyrazolato derivatives do

not readily lose carbon monoxide to give polymers [46]. However, they react with phosphines in thf to give the complexes $\text{Ru}_2(\text{CO})_4(\text{pz})_2(\text{PR}_3)_2$ (Scheme 5) [19].

The sawhorse-type structure of the bispyrazolato diruthenium tetracarbonyl complexes was established by a single-crystal X-ray structure analysis of the bismethyl-substituted derivative $\text{Ru}_2(\text{CO})_6(\text{pz})_2$, see Fig. 12. The pyrazolato bridges turned out as expected to be μ^2 - η^2 -*N,N* chelates, the two axial carbonyls being almost in line with the ruthenium–ruthenium axis of the undistorted sawhorse moiety [42].

By reacting the bulky 3,5-di-*tert*-butylpyrazole (pzH) with $\text{Ru}_3(\text{CO})_{12}$ in hexane at 170 °C (autoclave), Liu and co-workers isolated the unsaturated dinuclear bispyrazolato complex $\text{Ru}_2(\text{CO})_5(\text{pz})_2$, which reacts at room temperature with carbon monoxide to give the expected saturated hexacarbonyl complex, see Scheme 6 [48].

The reaction of $\text{Ru}_3(\text{CO})_9(\text{PPh}_3)_3$ or of $\text{Ru}(\text{CO})_3(\text{PPh}_3)_2$ with 1,2-diaminobenzene in refluxing mesitylene yields the diamido-bridged complex $\text{Ru}_2(\text{CO})_4(\text{HNC}_6\text{H}_4\text{NH})(\text{PPh}_3)_2$ [49,50]. Treatment of $\text{Ru}_3(\text{CO})_{12}$ with 1,3-diaryltriazines, RNNNR ($\text{R} = p\text{-C}_6\text{H}_4\text{X}$, $\text{X} = \text{H}, \text{Cl}, \text{Me}$), in boiling benzene under carbon monoxide atmosphere generates the bistriazenido complexes $\text{Ru}_2(\text{CO})_6(\text{RNNNR})_2$ that are also based on a diruthenium tetracarbonyl sawhorse backbone [51].

The axial carbonyl ligands can be displaced by other two-electron ligands such as amines (Scheme 7). Although a single-crystal X-ray structure analysis of the bistolylamine derivative $\text{Ru}_2(\text{CO})_4(\text{RNNNR})_2(\text{NH}_2\text{R})$ ($\text{R} = p\text{-C}_6\text{H}_4\text{Me}$) has been carried out, no structural data have been published; in addition no spectroscopic data of the known triazenido-bridged derivatives are available [51].

Pyridine reacts with $\text{Ru}_3(\text{CO})_{12}$ in *n*-heptane at 120 °C to give two isomers (head-to-head and head-to-tail) of the bispyridinato complexes $\text{Ru}_2(\text{CO})_6(\text{NC}_5\text{H}_4)_2$; in neat pyridine at 180 °C, the reaction leads to a pyridinato–bipyridinato complex involving a carbon–carbon coupling of two pyridine rings, see Fig. 13 [52].

The reaction of $\text{Ru}_3(\text{CO})_{12}$ with 2-hydroxypyridine (pyOH) in refluxing toluene produces the bispyridonato-bridged polymer $[\text{Ru}_2(\text{CO})_4(\text{Opy})_2]_n$ (Fig. 14), which dissolves in boiling acetonitrile to give the dinuclear complex $\text{Ru}_2(\text{CO})_4(\text{Opy})_2(\text{NCMe})_2$ [53]. The analogous reaction with pyridine-2-thiol (pySH) gives the bispyridylthiolato-bridged polymer $[\text{Ru}_2(\text{CO})_4(\text{Spy})_2]_n$ [54].

The analogous phosphine and phosphite derivatives $\text{Ru}_2(\text{CO})_4(\text{Opy})_2(\text{PPh}_3)_2$ (Fig. 14) and $\text{Ru}_2(\text{CO})_4(\text{Opy})_2(\text{P(OPH)}_3)_2$ have also been synthesized and isolated; the hexacarbonyl com-

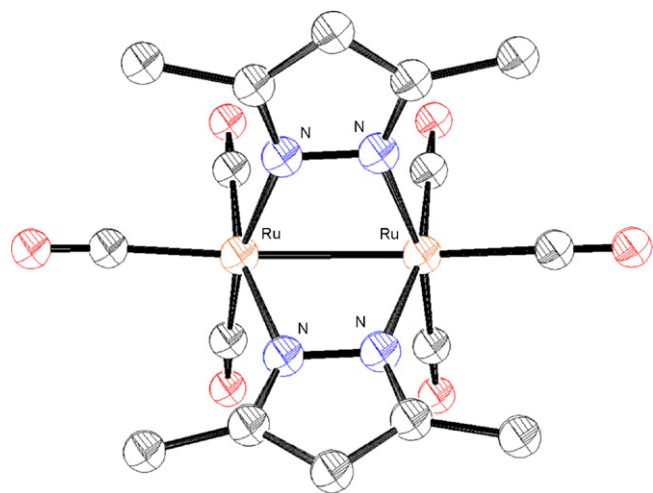
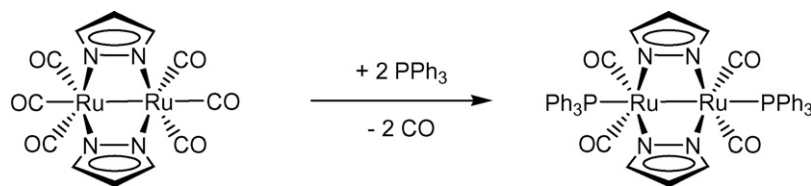
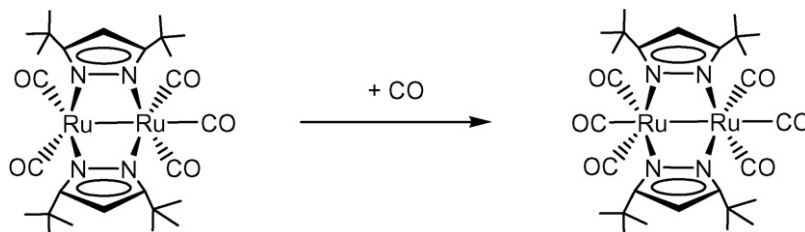

Fig. 12. Molecular structure of $\text{Ru}_2(\text{CO})_6(\text{pz})_2$ (pzH = 2,4-dimethylpyrazole) [42].



Scheme 5. Conversion of $\text{Ru}_2(\text{CO})_6(\text{pz})_2$ into $\text{Ru}_2(\text{CO})_4(\text{pz})_2(\text{PPh}_3)_2$ [19].



Scheme 6. Conversion of the unsaturated $\text{Ru}_2(\text{CO})_5(\text{pz})_2$ into $\text{Ru}_2(\text{CO})_6(\text{pz})_2$ [48].

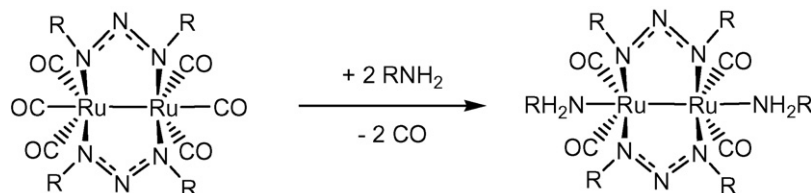

Scheme 7. Triazenido-bridged diruthenium tetracarbonyl sawhorse systems [51].

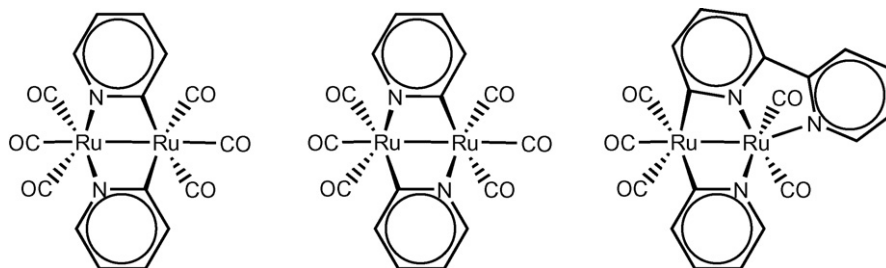

Fig. 13. Products obtained from the thermal reaction of $\text{Ru}_3(\text{CO})_{12}$ with pyridine [52].

plex $\text{Ru}_2(\text{CO})_6(\text{Opy})_2$ was observed in thf solution under a carbon monoxide atmosphere but could not be isolated due to rapid CO loss to give the polymer $[\text{Ru}_2(\text{CO})_4(\text{Opy})_2]_n$. The head-to-tail arrangement of the two μ_2 - η^2 -*N,O*-pyridonato bridges was deduced from the spectroscopic data, the $^{31}\text{P}\{^1\text{H}\}$ signals of the axial ligands in $\text{Ru}_2(\text{CO})_4(\text{Opy})_2(\text{PPh}_3)_2$ and $\text{Ru}_2(\text{CO})_4(\text{Opy})_2[\text{P}(\text{OPh})_3]_2$ being singlets and not doublets [53]. This was confirmed by the single-crystal X-ray structure analysis of $\text{Ru}_2(\text{CO})_4(\text{Opy})_2(\text{pyOH})_2$ [55]. Dimers of dinuclear pyridonato-bridged sawhorse complexes

of the type $[\text{Ru}_2(\text{CO})_4(\text{Opy})_2]$ have been synthesized by Maas and co-workers, the dinuclear units are linked by Ru–O bonds [56,57].

Bisoximato-bridged diruthenium tetracarbonyl complexes are accessible from the reaction of $\text{Ru}_3(\text{CO})_{12}$ with various oximes ($\text{R}^1\text{R}^2\text{CNOH}$) in refluxing cyclohexane. In the case of not too bulky aliphatic oximes ($\text{R}^1 = \text{R}^2 = \text{Me}$; $\text{R}^1 = \text{H}$, $\text{R}^2 = \text{Me}$; $\text{R}^1 = \text{Me}$, $\text{R}^2 = \text{Et}$), the reaction produces the dinuclear complexes $\text{Ru}_2(\text{CO})_4(\text{ONCR}^1\text{R}^2)_2(\text{HONCR}^1\text{R}^2)_2$ that contain two μ_2 - η^2 -*N,O*-oximato bridges as well as two intact oxime molecules as terminal ligands in the axial positions. In the case of the sterically more demanding benzaldehydeoxime or cyclohexanoneoxime, the axial oxime ligands are too loosely bound, so that the complexes cannot be isolated. However, stable bisoximato-bridged sawhorse complexes can be obtained also in this case by reacting these intermediates with triphenylphosphine (Scheme 8). In addition to phosphine derivatives, arsine, stibine, phosphite, sulfide and selenide (L) derivatives of the type $\text{Ru}_2(\text{CO})_4(\text{ONCR}^1\text{R}^2)_2\text{L}_2$ have been synthesized and characterized [20].

The head-to-tail arrangement of the two μ_2 - η^2 -*N,O*-oximato ligands in these complexes was demonstrated by a single-crystal X-ray structure analysis of $\text{Ru}_2(\text{CO})_4(\text{ONCMe}_2)_2(\text{HONCMe}_2)_2$ (Fig. 15); it also reveals intramolecular hydrogen bridging between the

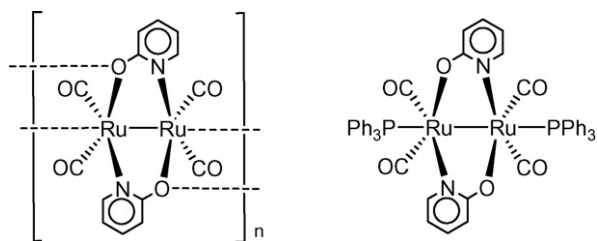
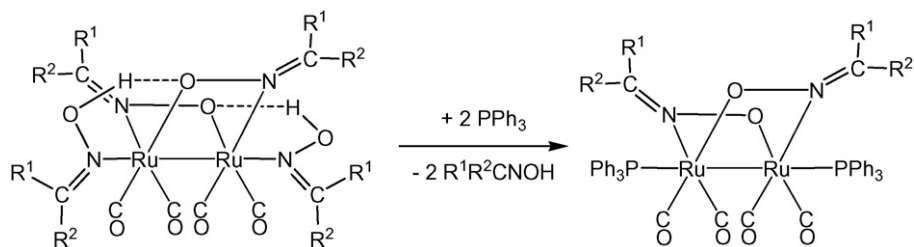

Fig. 14. Proposed structures for the sawhorse polymer $[\text{Ru}_2(\text{CO})_4(\text{Opy})_2]_n$ and of the dinuclear sawhorse complex $\text{Ru}_2(\text{CO})_4(\text{Opy})_2(\text{PPh}_3)_2$ [53].



Scheme 8. Conversion of the bisoximate complexes $\text{Ru}_2(\text{CO})_4(\text{ONCR}^1\text{R}^2)_2(\text{HONCR}^1\text{R}^2)_2$ into the derivatives $\text{Ru}_2(\text{CO})_4(\text{ONCR}^1\text{R}^2)_2(\text{PPh}_3)_2$ [20].

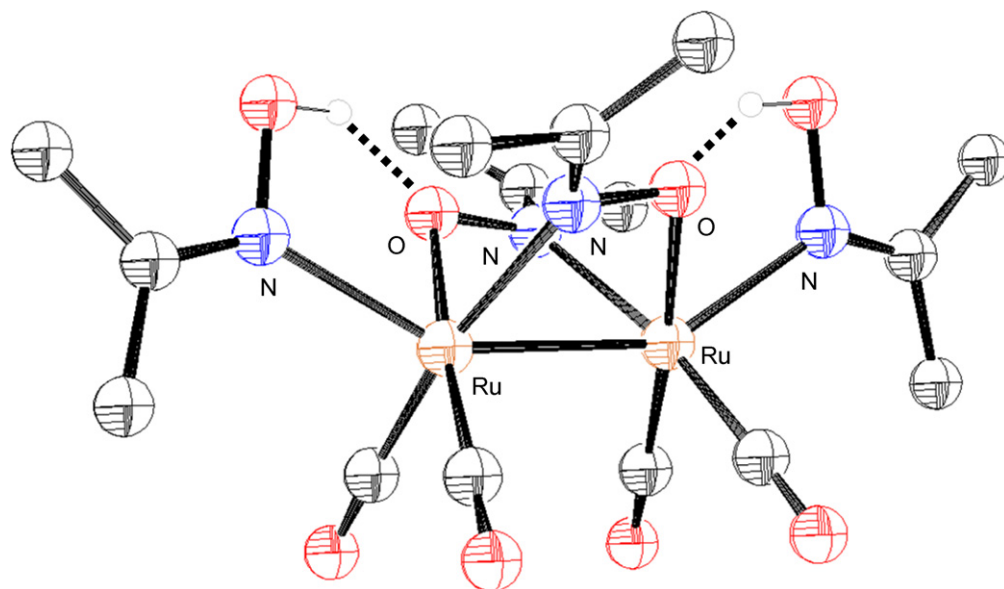

Fig. 15. Molecular structure of $\text{Ru}_2(\text{CO})_4(\text{ONCMe}_2)_2(\text{HONCMe}_2)_2$ [20].

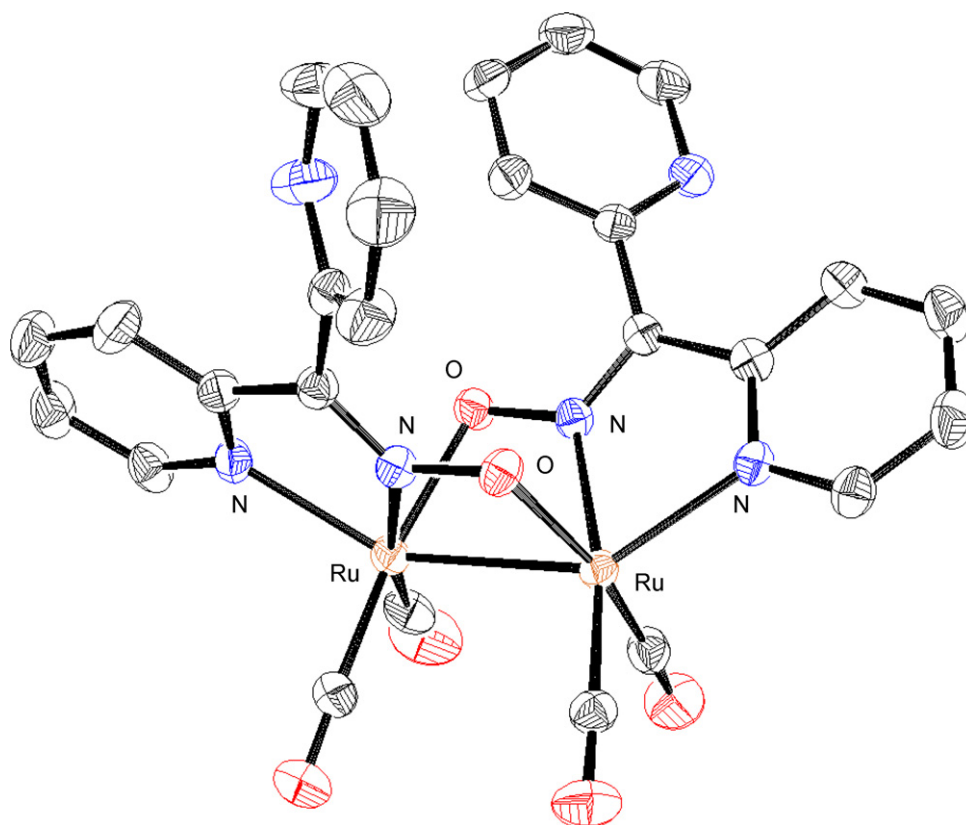

Fig. 16. Molecular structure of the complex $\text{Ru}_2(\text{CO})_4(\text{dpko})_2$ [58].

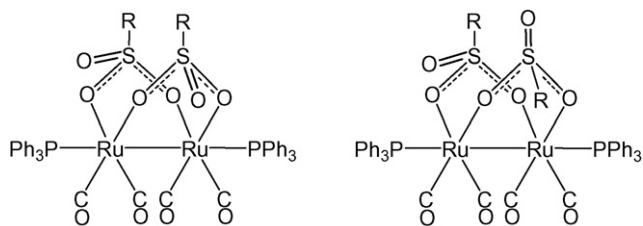

Fig. 17. The two possible isomers observed for the bis-sulfonato complexes $\text{Ru}_2(\text{CO})_4[\text{OOS}(\text{O})\text{R}]_2(\text{PPh}_3)_2$ [21].

hydroxy hydrogen atoms of the axial oxime ligands and the oxygen atoms of the oximato bridges [20]. From the reaction of $\text{Ru}_3(\text{CO})_{12}$ with bis(2-pyridyl)ketone oxime (dpkoH), the dinuclear complex $\text{Ru}_2(\text{CO})_4(\text{dpko})_2$ was isolated as a side-product, in which the diruthenium tetracarbonyl unit is bridged by two head-to-tail μ_2 - η^2 - N,O -bridges, while the axial positions are occupied by pyridyl substituents at the bridging ligands, see Fig. 16 [58].

The reaction of $\text{Ru}_3(\text{CO})_9(\text{PPh}_3)_3$ with *N*-methyl-2-mercaptoimidazole gives the sawhorse-type complex $\text{Ru}_2(\text{CO})_4[\text{SCN}(\text{CH}_2)_2\text{NMe}]_2(\text{PPh}_3)_2$ with a head-to-tail arrangement of the two μ_2 - η^2 - N,S -bridges [59]. With mercaptobenzothiazole, $\text{Ru}_3(\text{CO})_{12}$ reacts to give an incompletely characterized material that, upon recrystallization from pyridine yields crystals of $\text{Ru}_2(\text{CO})_4[\text{SCNC}_6\text{H}_4\text{S}]_2(\text{py})_2$ containing two μ_2 - η^2 - N,S -thiazolato ligands in a head-to-tail arrangement [60]. The reaction of $\text{RuCl}_3 \cdot n\text{H}_2\text{O}$ with 2-aminothiophenol, zinc powder and carbon monoxide in refluxing 2-methoxyethanol gives the complex $\text{Ru}_2(\text{CO})_6[\text{SC}_6\text{H}_4\text{NH}]$ containing an μ_2 - η^2 - N,S -aminothiophenolato ligand [61].

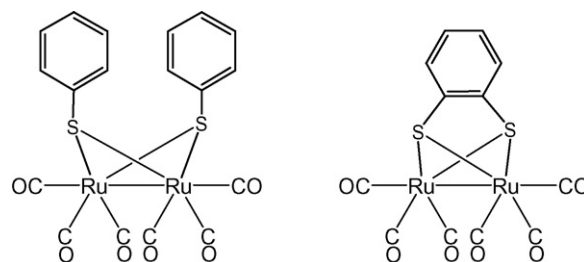

Fig. 19. Bisthiolato and dithiolato complexes based on a diruthenium tetracarbonyl sawhorse structure.

5. Sulfonato, thiolato and selenolato derivatives

Bissulfonato-bridged diruthenium tetracarbonyl complexes are accessible from the thermal reaction (100–120 °C) of $\text{Ru}_3(\text{CO})_{12}$ and the corresponding sulfonic acid in tetrahydrofuran solution (pressure vessel). The dinuclear sawhorse-type complexes have been isolated and characterized in the form of the triphenylphosphine derivatives $\text{Ru}_2(\text{CO})_4[\text{OOS}(\text{O})\text{R}]_2(\text{PPh}_3)_2$ according to Eqs. (4) and (5) [21].

In the case of methyl, ethyl or trifluoromethyl sulfonic acid, the complexes $\text{Ru}_2(\text{CO})_4[\text{OOS}(\text{O})\text{R}]_2(\text{PPh}_3)_2$ ($\text{R} = \text{Me}, \text{Et}, \text{CF}_3$) are obtained as the expected mixture of isomers in which the substituents R and the oxo group at the two tetrahedral sulfur atoms have the same or a different orientation (Fig. 17), as clearly observed by ^1H or ^{19}F NMR spectroscopy. In the case of tolyl sulfonic acid, the reaction seems to produce only one isomer, as the ^1H NMR spectrum of the solution shows only one set of signals; the single-crystal X-ray analysis of the product isolated in the solid state shows it to be

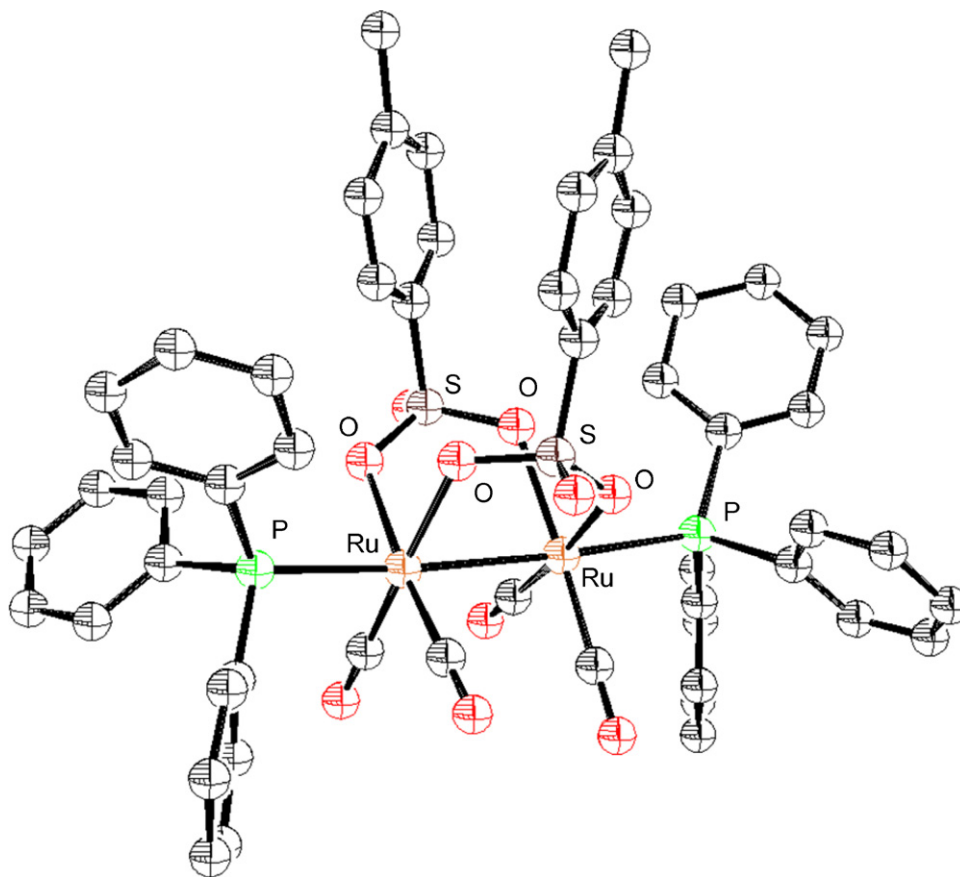

Fig. 18. Molecular structure of $\text{Ru}_2(\text{CO})_4[\text{OOS}(\text{O})\text{C}_6\text{H}_4\text{-p-Me}]_2(\text{PPh}_3)_2$ [21].

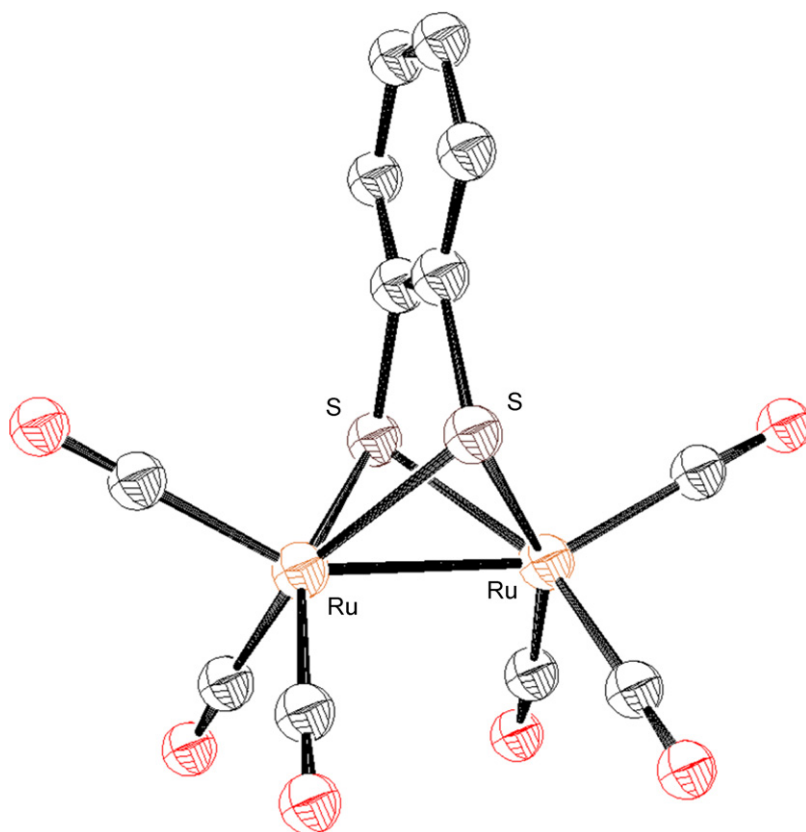
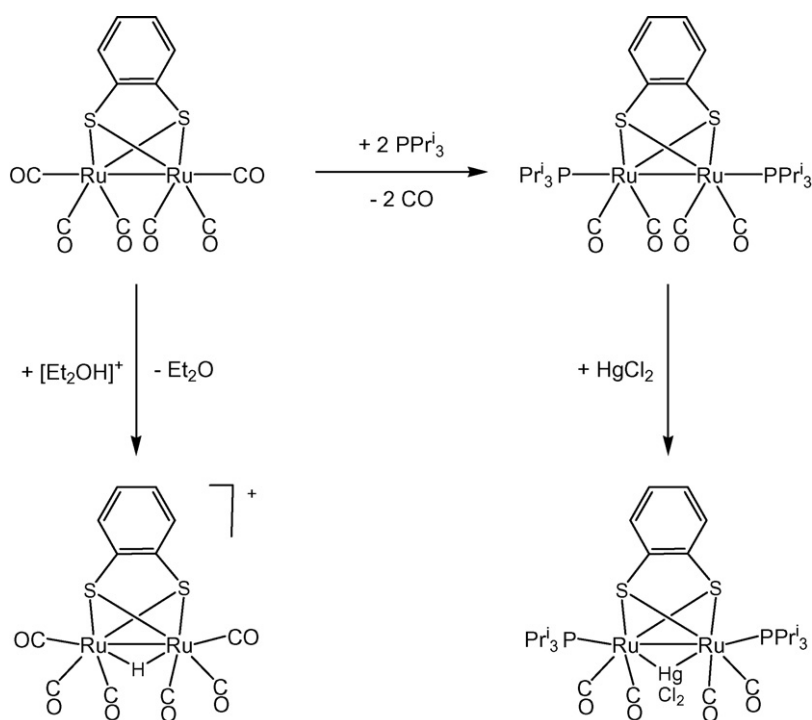

Fig. 20. Molecular structure of the dithiolato complex $\text{Ru}_2(\text{CO})_6(\text{S}_2\text{C}_6\text{H}_4)$ [64].

the isomer with two tolyl groups pointing into the same direction, see Fig. 18 [21].

The thiolato-bridged dinuclear complexes $\text{Ru}_2(\text{CO})_6(\text{SR})_2$ ($\text{R} = \text{Me}, \text{Et}, \text{Bu}^n, \text{Ph}$) as well as the corresponding polymers $[\text{Ru}_2(\text{CO})_4(\text{SR})_2]_n$, synthesized as early as 1967 by Lewis and

co-workers by reacting $\text{Ru}_3(\text{CO})_{12}$ with thiols [62], also have a diruthenium tetracarbonyl sawhorse structure (Fig. 19). In this early work, the characterization was based on micro-analytical and infrared data; structural information is only available for the ketylenyl derivative $\text{Ru}_2(\text{CO})_6(\text{SC}_{11}\text{H}_{19})_2$ obtained in 1988 by



Scheme 9. Reactivity of the dithiolato complex $\text{Ru}_2(\text{CO})_6(\text{S}_2\text{C}_6\text{H}_4)$ [66].

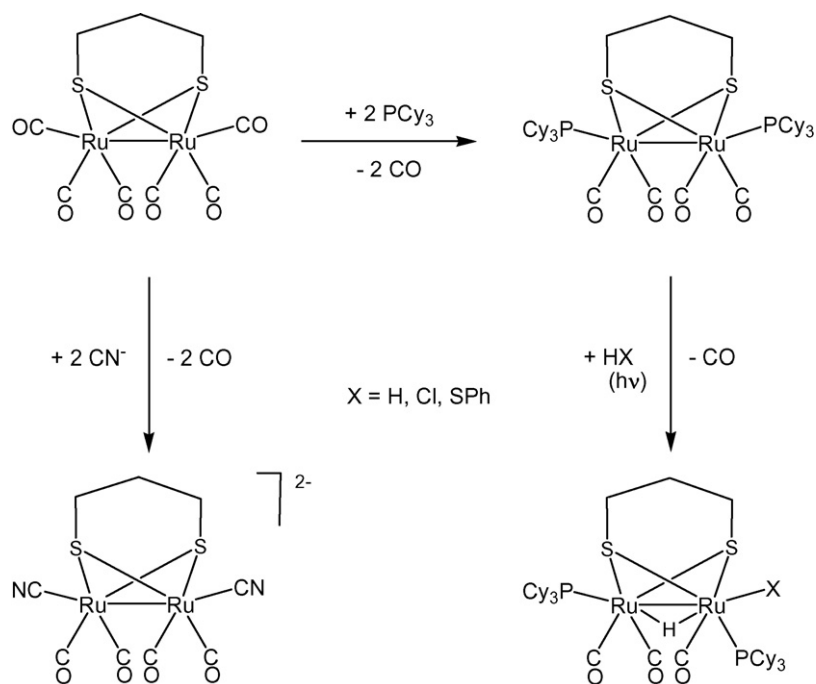

Scheme 10. Reactivity of the dithiolato complex $\text{Ru}_2(\text{CO})_6(\text{S}_2\text{C}_3\text{H}_6)$ [67,68].

Behrens and Seitz [63]. On the other hand, structural information is available for the dithiolato-bridged complexes $\text{Ru}_2(\text{CO})_6(\text{S}_2\text{C}_6\text{H}_4)$ (Fig. 19) [64] and $\text{Ru}_2(\text{CO})_6[(\text{SC}_5\text{H}_4)_2\text{Fe}]$ [65], both compounds being accessible from the thermal reaction of $\text{Ru}_3(\text{CO})_{12}$ with the corresponding dithiol.

The single-crystal X-ray structure analysis of $\text{Ru}_2(\text{CO})_6(\text{S}_2\text{C}_6\text{H}_4)$ (Fig. 20) clearly demonstrates that in thiolato-bridged sawhorse complexes the axial carbonyl ligands are bent upwards with respect to the $\text{Ru}_2(\text{CO})_4$ sawhorse unity [64]. This is a consequence of the thiolato bridges being monohapto ($\mu_2\text{-}\eta^1$) ligands with only one atom instead of two or three in the bridge. The same bending is observed in $\text{Ru}_2(\text{CO})_6[(\text{SC}_5\text{H}_4)_2\text{Fe}]$ [65] and also in $\text{Ru}_2(\text{CO})_6(\text{SC}_{11}\text{H}_{19})_2$ [63].

The benzodithiolato complex $\text{Ru}_2(\text{CO})_6(\text{S}_2\text{C}_6\text{H}_4)$ was also obtained in good yield by a simple one-pot synthesis starting from $\text{RuCl}_3 \cdot n\text{H}_2\text{O}$, benzene-1,2-dithiol and metallic zinc in refluxing 2-methoxymethanol in the presence of carbon monoxide [66]. The reactivity of this complex was studied by Cabeza. The axial carbonyl ligands of $\text{Ru}_2(\text{CO})_6(\text{S}_2\text{C}_6\text{H}_4)$ are easily replaced by phosphines such as PPr^i_3 , the derivative obtained $\text{Ru}_2(\text{CO})_4(\text{S}_2\text{C}_6\text{H}_4)(\text{PPr}^i_3)_2$ as well as the parent compound react with electrophiles such as the diethyloxonium cation or mercuric chloride to give the cationic hydrido complexes $[\text{HRu}_2(\text{CO})_4(\text{S}_2\text{C}_6\text{H}_4)\text{L}_2]^+$ or the adducts $\text{HRu}_2(\text{CO})_4(\text{S}_2\text{C}_6\text{H}_4)\text{L}_2$ ($\text{L} = \text{CO}, \text{PPr}^i_3$) [66] (Scheme 9).

The reactivity of the aliphatic dithiolato complex $\text{Ru}_2(\text{CO})_6(\text{S}_2\text{C}_3\text{H}_6)$ was studied in detail by Rauchfuss because of its resemblance of the active site of iron-only hydrogenase [67,68]. The axial carbonyl ligands can be exchanged against phosphine or cyano ligands, the bis(tricyclohexylphosphine) derivative undergoes photodecarbonylation with addition of HX ($\text{X} = \text{H}, \text{Cl}, \text{SPh}$), see Scheme 10 [68].

The single-crystal X-ray structure analysis of $[\text{NEt}_4]_2[\text{Ru}_2(\text{CO})_4(\text{S}_2\text{C}_3\text{H}_6)(\text{CN})_2]$ shows the diruthenium tetracarbonyl sawhorse-based anion to contain two axial cyano ligands that are also bent upwards, the angles Ru-Ru-CN being around 148° (Fig. 21). The ruthenium-ruthenium distance of $2.6667(7) \text{ \AA}$ is clearly in the range of a metal-metal single bond [68].

If the thiol used in the reaction with $\text{Ru}_3(\text{CO})_{12}$ contains a pending phosphine side-arm, the axial positions at the $\text{Ru}_2(\text{CO})_4$ sawhorse will be occupied by the phosphorus atom linked to the thiolato bridge. This is the case in $\text{Ru}_2(\text{CO})_4(\text{SC}_6\text{H}_4\text{PPh}_2)_2$, synthesized by Cabeza from dodecacarbonyltriruthenium and 2-(diphenylphosphido)thiophenol [69].

A selenium analog of the bithiolato sawhorse complexes, the bis(diphenylphosphido)methane (dppm) complex $\text{Ru}_2(\text{CO})_4(\text{SePh})_2(\text{dppm})$ containing two phenylselenolato bridges over a diruthenium tetracarbonyl sawhorse unit is also known; it is accessible from $\text{Ru}_3(\text{CO})_{10}(\text{dppm})$ and PhSeSePh in refluxing benzene [70]. $\text{Ru}_3(\text{CO})_{12}$ reacts with PhSeSePh in benzene at 60°C to give $\text{Ru}_2(\text{CO})_6(\text{SePh})_2$ [71], an improved synthesis of which was reported by Cabeza, who used refluxing tetrahydrofuran as solvent [72].

6. Phosphato, phosphinato, phosphinito and phosphido derivatives

Dodecacarbonyltriruthenium reacts with various organic derivatives of phosphorus oxoacids to give $\text{Ru}_2(\text{CO})_4$ sawhorse-type complexes. Thus, reactions with $\text{R}_2\text{PO}_2\text{H}$ (diorganylphosphinic acid, derived from phosphinic acid) and with $(\text{PhO})_2\text{PO}_2\text{H}$ (diphenylphosphate, a di-ester derivative of phosphoric acid) are known (Fig. 22).

When dodecacarbonyltriruthenium is treated with an excess of dimethylphosphinic acid in refluxing tetrahydrofuran, a copious yellow micro-crystalline precipitate of $[\text{Ru}_2(\text{CO})_4(\text{OOPMe}_2)_2]_n$ is obtained according to Eqs. (4) and (5). This polymeric material reacts in hot thf with triphenylphosphine to give $\text{Ru}_2(\text{CO})_4(\text{OOPMe}_2)_2(\text{PPh}_3)_2$ in good yield [73]. From the analogous reaction with diphenylphosphinic acid, $[\text{Ru}_2(\text{CO})_4(\text{OOPPh}_2)_2]_n$ [73] and $\text{Ru}_2(\text{CO})_4(\text{OOPPh}_2)_2(\text{PPh}_3)_2$ [73,74] have been isolated. The phosphinato-bridged sawhorse complexes $\text{Ru}_2(\text{CO})_4(\text{OOPPh}_2)_2[\text{As}(\text{C}_6\text{H}_4\text{-}p\text{-Me})_3]_2$ and $\text{Ru}_2(\text{CO})_4[\text{OOP}(\text{C}_6\text{H}_4\text{-}p\text{-NMe}_2)_2]_2(\text{PPh}_3)_2$ are also known [74].

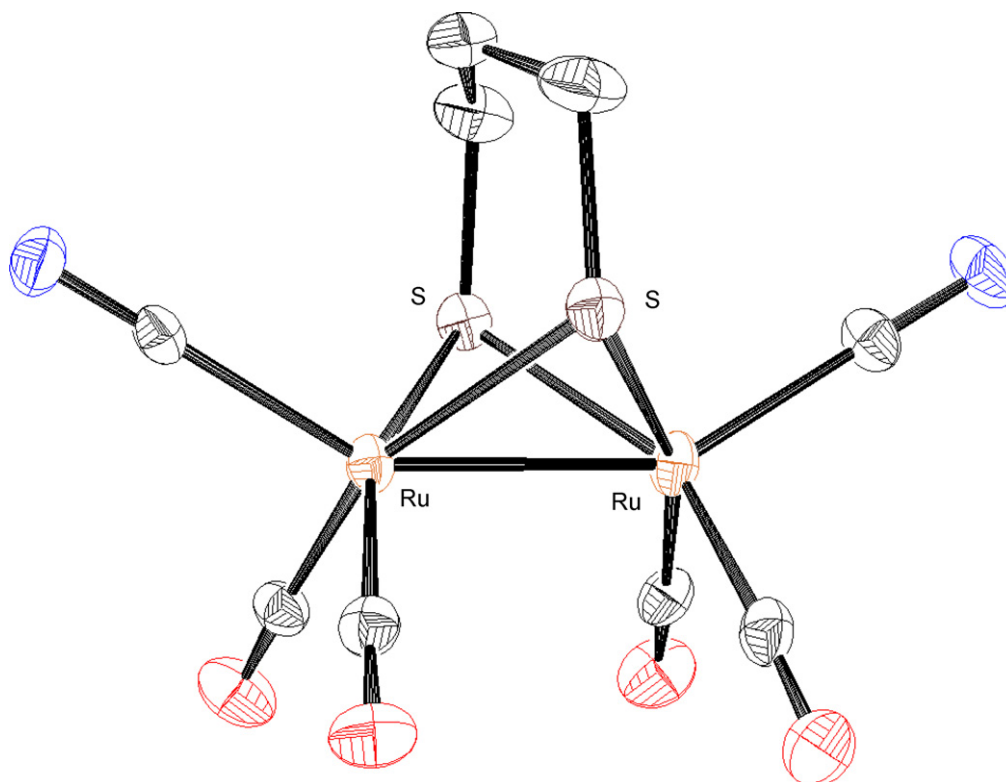

Fig. 21. Molecular structure of the anion $[\text{Ru}_2(\text{CO})_4(\text{S}_2\text{C}_3\text{H}_6)(\text{CN})_2]^{2-}$ [68].

The molecular structure of $\text{Ru}_2(\text{CO})_4(\text{OOPPh}_2)_2(\text{PPh}_3)_2$ was solved by single-crystal X-ray structure analysis (Fig. 23). As far as the surprisingly large twist angle of 22.0° is concerned (deviation from the idealized eclipsed geometry), initially attributed to the steric interactions of the phenyl groups, no direct correlation between the character of the ligands and the dihedral twist has been found, since the dimethyl derivative $\text{Ru}_2(\text{CO})_4(\text{OOPMe}_2)_2(\text{PPh}_3)_2$ shows an even larger twist (26.1°) [73].

In same fashion, the dinuclear diphenylphosphato-bridged complexes $\text{Ru}_2(\text{CO})_4[\text{OOP}(\text{OPh})_2]_2(\text{PPh}_3)_2$ (Fig. 22) and $\text{Ru}_2(\text{CO})_4[\text{OOP}(\text{OPh})_2]_2(\text{NCMe})_2$ have been synthesized and spectroscopically characterized; however, all attempts to isolate them in an analytically pure form failed due to the high reactivity of these complexes [75].

Dinuclear complexes containing a $\text{Ru}_2(\text{CO})_4$ sawhorse unit and with two phosphido bridges ($\mu_2\text{-}\eta^1\text{-PR}_2$) or with one phosphido and with one phosphinito bridge ($\mu_2\text{-}\eta^2\text{-OPR}_2$) are also known (Fig. 24). The reaction of the carboxylato-bridged diphenyl- or dicyclohexylphosphine derivatives $\text{Ru}_2(\text{CO})_4(\text{OOCeEt})_2(\text{PHR}_2)_2$ with carbon monoxide under pressure (50 bar) in thf solution (160°C) leads to a mixture of $\text{Ru}_2(\text{CO})_6(\text{PR}_2)_2$ (major product) and $\text{Ru}_2(\text{CO})_6(\text{OPR}_2)(\text{PR}_2)$ (minor product), R being Ph or Cy, accord-

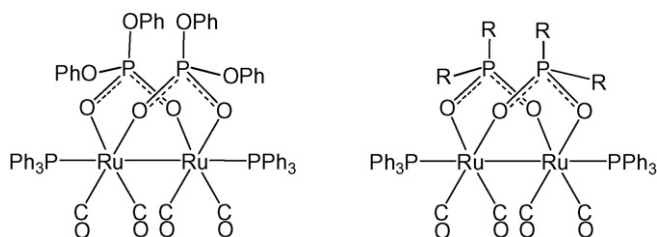
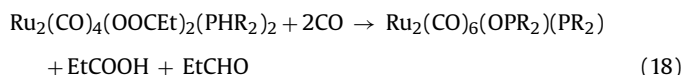
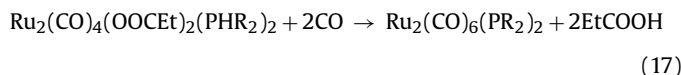

Fig. 22. Phosphato [75] and phosphinito [73,74] complexes based on a diruthenium tetracarbonyl sawhorse structure.

ing to Eqs. (17) and (18) [76]. The molecular structure of the mixed complex $\text{Ru}_2(\text{CO})_6(\text{OPCy}_2)(\text{PCy}_2)$ is shown in Fig. 25



The bis(diphenylphosphido) derivative $\text{Ru}_2(\text{CO})_6(\text{PPh}_2)_2$ was already known since 1972, when Stone and co-workers isolated this compound in trace amounts from the pyrolysis of $\text{Ru}_3(\text{CO})_3(\text{PPh}_3)_3$ [77]. It was also obtained as a side-product in many reactions involving $\text{Ru}_3(\text{CO})_{12}$ and diphenylphosphine [78–84].

The molecular structure of the bis(diphenylphosphido) complex $\text{Ru}_2(\text{CO})_6(\text{PPh}_2)_2$ was finally solved by single-crystal X-ray structure analysis only in 1990 by Haines and co-workers [82]. The two ruthenium atoms are linked not only by a formal metal–metal single bond (2.820 Å), but also by two bridging diphenylphosphido ligands. The Ru_2P_2 framework adopts a butterfly geometry with the dihedral angle between the two Ru_2P planes being 75.1° . As in all sawhorse-type complexes with monohapto ($\mu_2\text{-}\eta^1$) bridging ligands, the two axial carbonyl ligands are considerably bent upwards (Fig. 26).

Other phosphido-bridged sawhorse complexes include $\text{Ru}_2(\text{CO})_6(\text{PR}_2)_2$ derivatives with $\text{R} = m\text{-C}_6\text{H}_4\text{Me}$ from the pyrolysis of $\text{Ru}_3(\text{CO})_3(\text{PR}_3)_3$ [77] and with $\text{R} = \text{Me}$ from the reaction of $\text{Ru}_3(\text{CO})_{12}$ with P_2Me_4 [85].

A dinuclear ruthenium complex containing a phosphido and a thiolato bridge over a $\text{Ru}_2(\text{CO})_4$ sawhorse backbone has been reported without any synthetic and spectroscopic details. $\text{Ru}_2(\text{CO})_6(\text{PPh}_2)(\text{SPh})$ was obtained from $\text{Ru}_3(\text{CO})_{12}$ with Ph_2PSPH in a reaction which involves the cleavage of the phosphorus–sulfur bond [86].

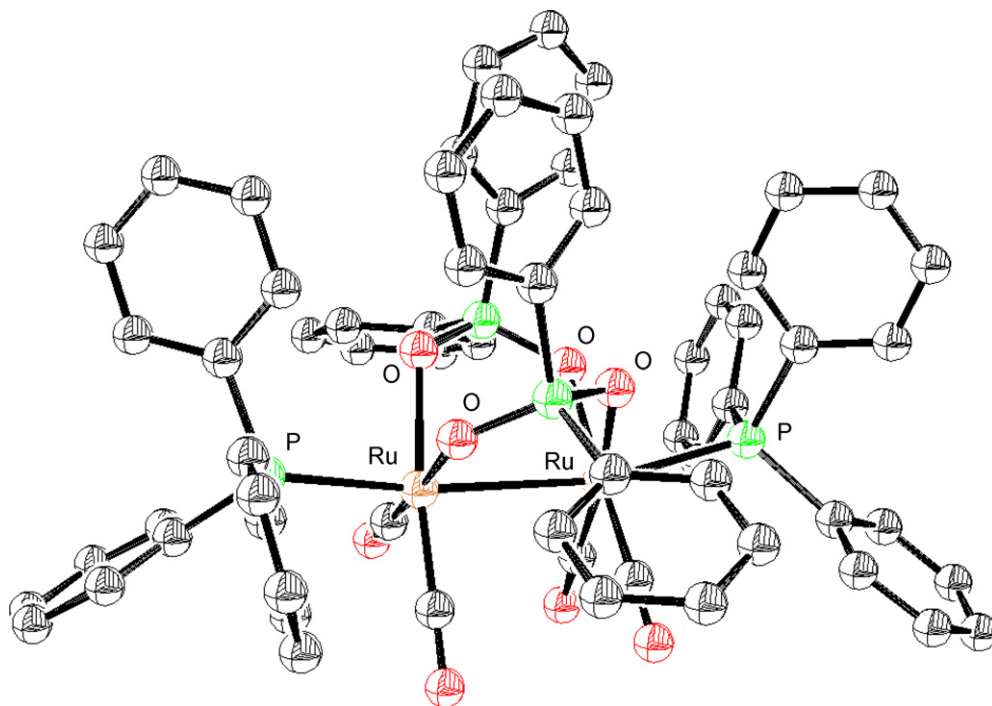

Fig. 23. Molecular structure of the complex $\text{Ru}_2(\text{CO})_4(\text{OOPPh}_2)_2(\text{PPh}_3)_2$ [73].

7. Other derivatives

Several diruthenium complexes containing bridging hydrocarbon ligands are known, which also contain a $\text{Ru}_2(\text{CO})_4$ sawhorse moiety. However, since the chemistry of these compounds is primarily focused on the hydrocarbon ligands, they are normally considered as organometallic hydrocarbon derivatives rather than as $\text{Ru}_2(\text{CO})_4$ sawhorse-type derivatives. Therefore, only some typical examples of these borderline cases are presented here.

The molecules $\text{Ru}_2(\text{CO})_6(\text{C}_8\text{H}_8)$ [87,88] and $\text{Ru}_2(\text{CO})_5(\text{C}_{16}\text{H}_{16})$ [89,90], formed in the reaction of cyclooctatetraene with $\text{Ru}_3(\text{CO})_{12}$ (the latter one also with $\text{H}_4\text{Ru}_4(\text{CO})_{12}$) have been shown to have a diruthenium tetracarbonyl sawhorse backbone. However, the bonding of the cyclic hydrocarbon ligand caused some controversy and frustration even after detailed NMR and X-ray studies [87–91], because these molecules are fluxional in solution. They have been among the first examples of stereochemically nonrigid organometallic molecules [87,92].

The cyclooctatetraene ligand in $\text{Ru}_2(\text{CO})_6(\text{C}_8\text{H}_8)$ is considered to be a $\mu_2\text{-}\eta^6$ ligand, in which there is one non-coordinated carbon-carbon double bond, while six π electrons are delocalized and ascertain the bonding to the diruthenium backbone (Fig. 27) [88]. The hydrocarbon ligand in $\text{Ru}_2(\text{CO})_5(\text{C}_{16}\text{H}_{16})$ is a bicyclic Diels–Alder dimer of cyclooctatetraene and can be considered as a $\mu_2\text{-}\eta^8$ ligand, in which there are two non-coordinated carbon-carbon double bonds, while six delocalized π electrons and

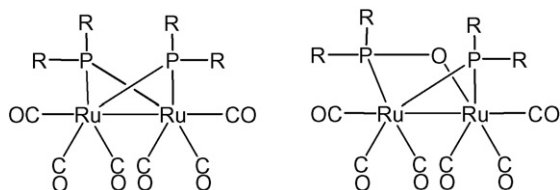

Fig. 24. Diruthenium tetracarbonyl sawhorse complexes containing phosphido and phosphinito bridges.

a coordinated carbon-carbon double bond ascertain the bonding to the diruthenium backbone, see Figs. 27 and 28 [89].

The “lantern” complexes $\text{Ru}_2(\text{CO})_4\text{X}_2\text{L}_2$ ($\text{X} = \text{Cl}, \text{Br}, \text{I}$; $\text{L} = \text{PBU}^t_2\text{Ph}$, PBU^t_2Tol) [93,94] and $\text{Ru}_2(\text{CO})_4\text{X}_2\text{L}_2$ ($\text{X} = \text{Cl}, \text{Br}, \text{I}$; $\text{L} = \text{PBU}^t_3$) [95] are, in principle, also sawhorse-type systems, however, as the two bridging ligands are formed only by a single atom ($\mu_2\text{-X}$, $\text{X} = \text{Cl}, \text{Br}, \text{I}$), they are normally not considered as sawhorse complexes.

8. Catalytically active $\text{Ru}_2(\text{CO})_4$ complexes

Sawhorse-type diruthenium tetracarbonyl complexes have been used as catalysts for isomerization, hydrogenation, and carbonylation reactions as well as for carbon-oxygen and carbon-carbon coupling reactions; in some cases they have been observed in catalytic reactions for which $\text{Ru}_3(\text{CO})_{12}$ was used as catalyst precursor. In most cases, carboxylato-bridged derivatives were involved in the catalytic reactions.

Isomerization of hex-1-ene to internal hexenes (*trans*-hex-2-ene being the main product) was observed in the presence of $\text{Ru}_2(\text{CO})_4(\text{OOCMe})_2(\text{PBU}^n_3)_2$ (*n*-heptane, catalyst/substrate ratio 1:500, 80 °C) according to Eq. (19); the olefin complexes “ $\text{Ru}_2(\text{CO})_4(\text{OOCMe})_2(\text{PBU}^n_3)$ (hexene)” have been detected in solution by NMR spectroscopy [96]. With $[\text{Ru}_2(\text{CO})_4(\text{OOCMe})_2][\text{MeCOO}]$ ($\text{L} = 1,1'$ -biisoquinoline) as the catalyst, hex-1-ene is hydrogenated under hydrogen pressure (100 bar) to give *n*-hexane ($\text{MeOH}/\text{H}_2\text{O}$, catalyst/substrate 1:1000, 100 bar, 60 °C, 6 h, 87% conversion) according to Eq. (20) [36].

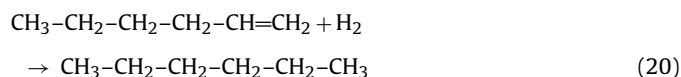
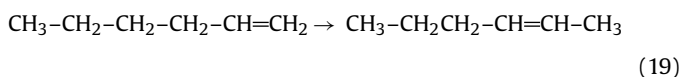

Similarly, the hydrogenations of cyclohexene and of styrene have been reported using as catalysts $\text{Ru}_2(\text{CO})_4(\text{OOCMe})_2(\text{PBU}_3)_2$

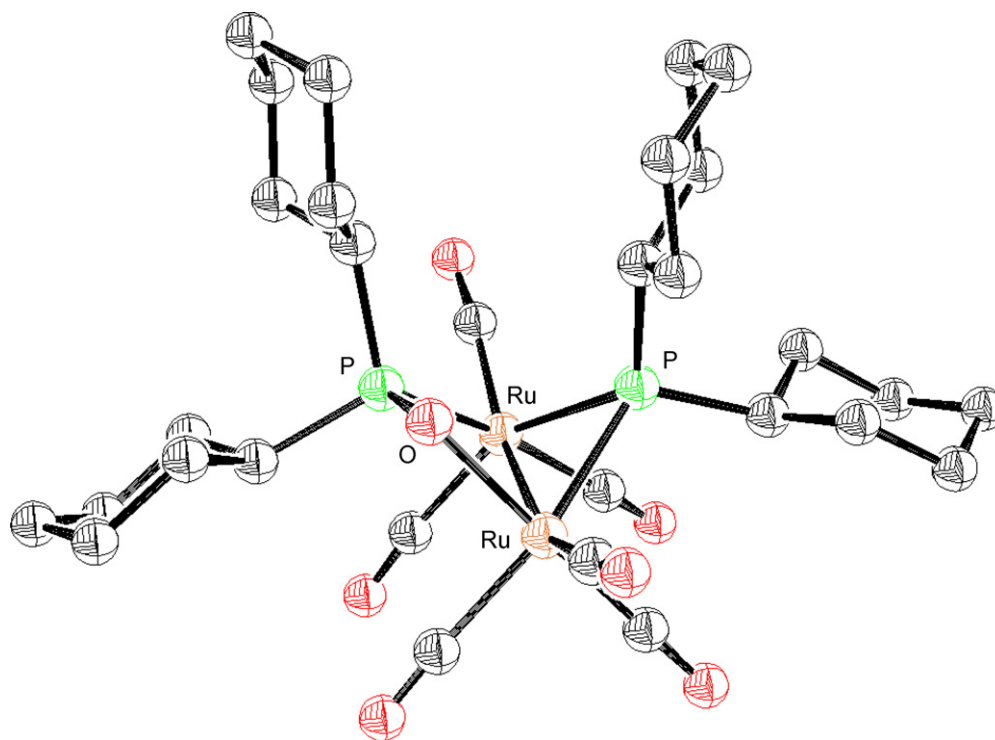

Fig. 25. Molecular structure of the mixed complex $\text{Ru}_2(\text{CO})_6(\text{OPCy}_2)(\text{PCy}_2)$ [76].

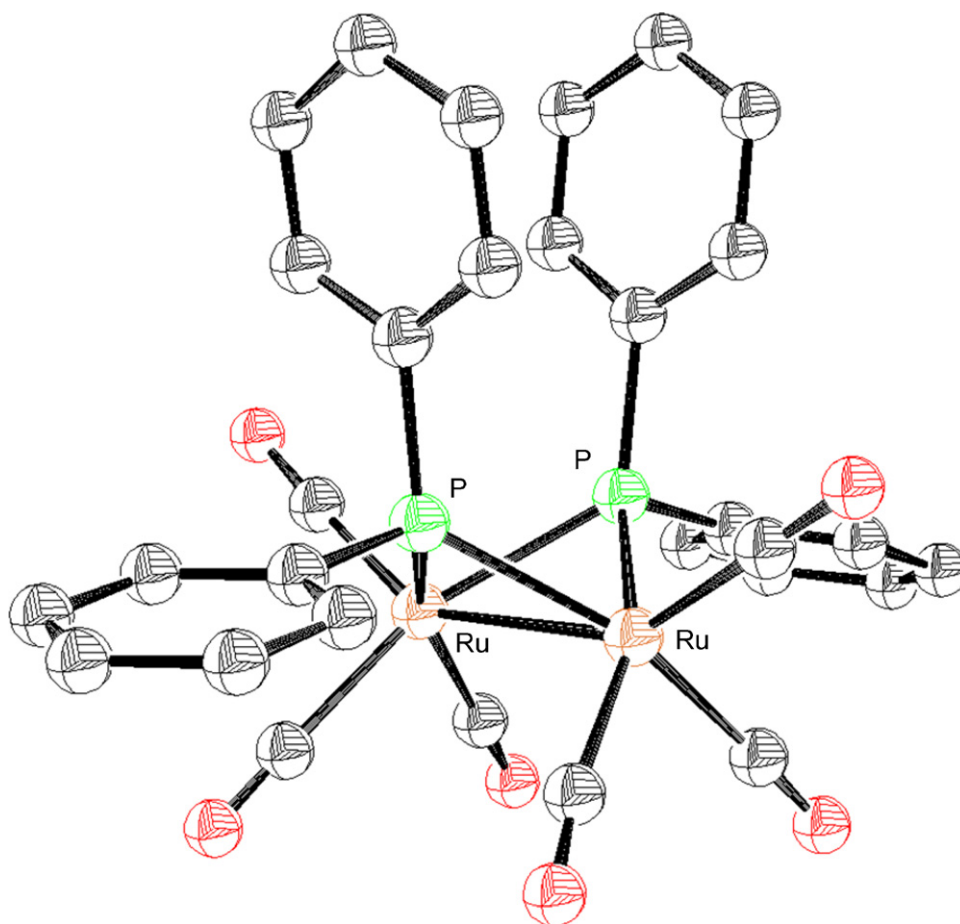

Fig. 26. Molecular structure of the bisphosphido complex $\text{Ru}_2(\text{CO})_6(\text{PPh}_2)_2$ [82].

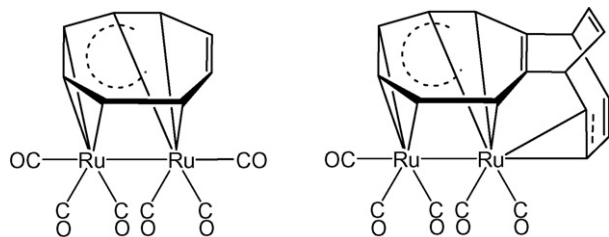
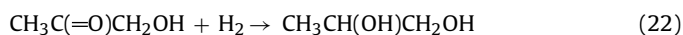
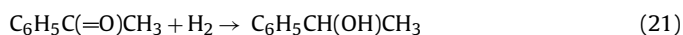

Fig. 27. Diruthenium tetracarbonyl sawhorse complexes containing cyclic hydrocarbon bridges, $\text{Ru}_2(\text{CO})_6(\text{C}_8\text{H}_8)$ and $\text{Ru}_2(\text{CO})_5(\text{C}_{16}\text{H}_{16})$.

or $\text{Ru}_2(\text{CO})_4[\text{OOCCH}(\text{OH})\text{CH}(\text{OH})\text{COO}](\text{bipy})_2$, respectively. In the first case (no solvent indicated, catalyst/substrate ratio 1:2300, 130 bar H_2 , 60 °C), cyclohexane was formed in 22% yield after 22 h [97]; in the second case (methanol/water, catalyst/substrate ratio 1:100, 100 bar, 100 °C), ethyl benzene was obtained in 91% yield after 6 h [98]. Acetone is converted into isopropanol under hydrogen pressure (100 °C, 100 bar) in the presence of $[\text{Ru}_2(\text{CO})_4(\text{OOCMe})_2(\text{bipy})_2][\text{MeCOO}]$ with catalytic turnover frequencies up to 142 h^{-1} [99]. $\text{Ru}_2(\text{CO})_4(\text{OOCMe})_2(\text{PBu}_3)_2$ also catalyzes the hydrogenation of acetophenone to (racemic) 1-phenylethanol according to Eq. (21) at 120 °C (no solvent indicated, catalyst/substrate ratio 1:2300, 130 bar H_2), the conversion being 66% after 22 h [97].



Chiral hydrogenation variants using chiral $\text{Ru}_2(\text{CO})_4$ complexes have been studied, but the enantioselectivities obtained were disappointing. The hydrogenation of hydroxyacetone according to Eq. (22) using $\text{Ru}_2(\text{CO})_4(\text{OOCMe})_2(\text{diop})$, diop being 4,5-bis(diphenylphosphinomethyl)-2,2-dimethyl-1,3-dioxolan, [33] or $\text{Ru}_2(\text{CO})_4[\text{OOCPh}(\text{OMe})\text{CF}_3]_2(\text{cyclop})$, cyclop being 1,2-bis(diphenylphosphinomethyl)cyclohexane, [100] as chiral catalysts (tetrahydrofuran, catalyst/substrate ratio 1:1000, 40 bar H_2 , 120 °C, 20 h) gave only 14% ee (67% conversion) and 8% ee (48% conversion), respectively. For the hydrogenation of tiglic acid to give 2-methylbutanoic acid [Eq. (23)] with $\text{Ru}_2(\text{CO})_4(\text{OOCCHMeEt})_2(\text{diop})$ in a solvent mixture of toluene and methanol (100 °C, 100 bar H_2 , catalyst/substrate ratio 1:655, 4 h), the optical purity was 37% (95% conversion) [31].



The hydrogenation of aliphatic monocarboxylic acids using $\text{H}_4\text{Ru}_4(\text{CO})_8(\text{PBu}_3)_4$ as catalyst precursor gives the corresponding carboxylic esters; in some cases the intermediary alcohols are observed as side-products. With acetic acid as substrate, ethyl acetate is obtained [Eq. (24)] exclusively at 180 °C and 130 bar (catalyst/substrate ratio 1:3600, conversion 37% after 24 h), the solution containing $\text{Ru}_2(\text{CO})_4(\text{OOCMe})_2(\text{PBu}_3)_2$; dicarboxylic acids lead mainly to lactones [24]. The hydrogenation of dimethyl oxalate using $\text{Ru}_2(\text{CO})_4(\text{OOCMe})_2(\text{PBu}_3)_2$ as catalyst (180 °C, 130 bar), methyl glycolate is obtained [Eq. (25)], exclusively in benzene as solvent, in methanol ethylene glycol is observed as side-product [101–103].



Diruthenium tetracarbonyl complexes are also reported to catalyze carbonylation reactions. The hydroformylation of oct-1-ene to give nonanal (75% *n*) according to Eq. (26) works with various $\text{Ru}_2(\text{CO})_4(\text{OOCR})_2\text{L}_2$ complexes in the presence of base (NEt_3); the best results (96% yield) are obtained for $\text{R}=\text{Me}$ and $\text{L}=\text{PPh}_3$

(toluene/water, catalyst/base/substrate 1:3:400, 80 °C, 15 bar CO , 15 bar H_2 , 20 h) [100]. The carbonylation of cyclic amines to give the corresponding *N*-formyl amine in 6–45% yield according to Eq. (27) was reported to be catalyzed by either $[\text{Ru}_2(\text{CO})_4(\text{OOCMe})_2]_n$ or by $\text{Ru}_3(\text{CO})_{12}$ at 75 °C; in both cases the amine complex $\text{Ru}_2(\text{CO})_4(\text{OOCR})_2\text{L}_2$ ($\text{L}=\text{amine}$) was found in the solution [104]. The synthesis of *N,N'*-diphenyl urea by reductive carbonylation of nitrobenzene and aniline [Eq. (28)] was reported to work in the presence of $[\text{Ru}_2(\text{CO})_4(\text{OOCMe})_2]_n$ as catalyst (toluene, 160 °C, 50 bar CO), the catalytic turnover frequency being 110 h^{-1} [105].

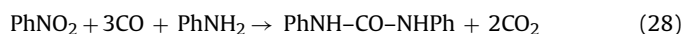
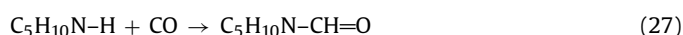

A convenient access to anhydrous acetone (85% yield) was found by catalytic carbonylation of acetone oxime [Eq. (29)], followed by decarboxylation to give acetone imine [Eq. (30)], which cyclotrimerizes with elimination of ammonia [Eq. (31)]. This first reaction of this sequence is catalyzed (cyclohexane, 50 bar CO , 100 °C, 17 h, catalytic turnover number 827) by the bisoximato complex $\text{Ru}_2(\text{CO})_4(\text{ONCMe}_2)_2(\text{Me}_2\text{CNOH})_2$; the complex $\text{Ru}_2(\text{CO})_5(\text{ONCMe}_2)_2(\text{Me}_2\text{CNOH})$ was isolated in 80% yield from the reaction mixture and structurally characterized [106].

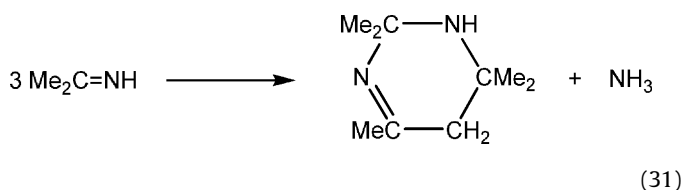
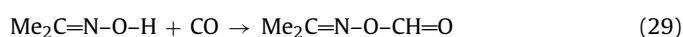

Carbon–oxygen coupling reactions catalyzed by $\text{Ru}_2(\text{CO})_4$ complexes have been reported for the synthesis of vinyl esters. Diphenylacetylene reacts with acetic acid in toluene in the presence of $[\text{Ru}_2(\text{CO})_4(\text{OOCMe})_2]_n$ at 145 °C to give predominantly (85%) *Z*-acetoxystilbenes, according to Eq. (32), the catalytic turnover being 25 [107]. The reaction, which can be generalized to other acid and alkynes [Eq. (33)], was also catalyzed by $\text{Ru}_3(\text{CO})_{12}$ as catalyst precursor; from the reaction mixtures the diruthenium tetracarbonyl complexes $\text{Ru}_2(\text{CO})_4(\text{OOCPh})_2(\text{PhCOOH})_2$ and $[\text{Ru}_2(\text{CO})_4(\text{OOCBu}^s)_2(\text{Bu}^s\text{COOH})]_2$ have been isolated and reused as catalysts [10]. Similarly, the reaction of formic acid with hex-1-yne to give the corresponding enol formate (toluene, 90 °C) was catalyzed with high yield (94% conversion) by $\text{Ru}_2(\text{CO})_4(\text{OOCMe})_2(\text{PPh}_2\text{C}_5\text{H}_4\text{TiC}_5\text{H}_5)_2$ [108].

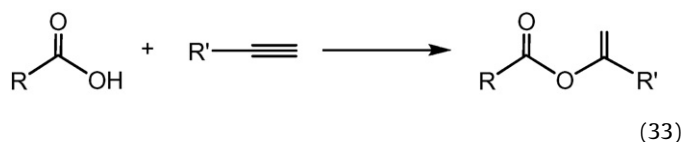
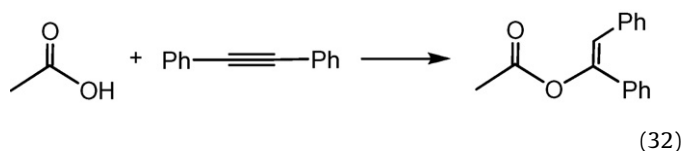

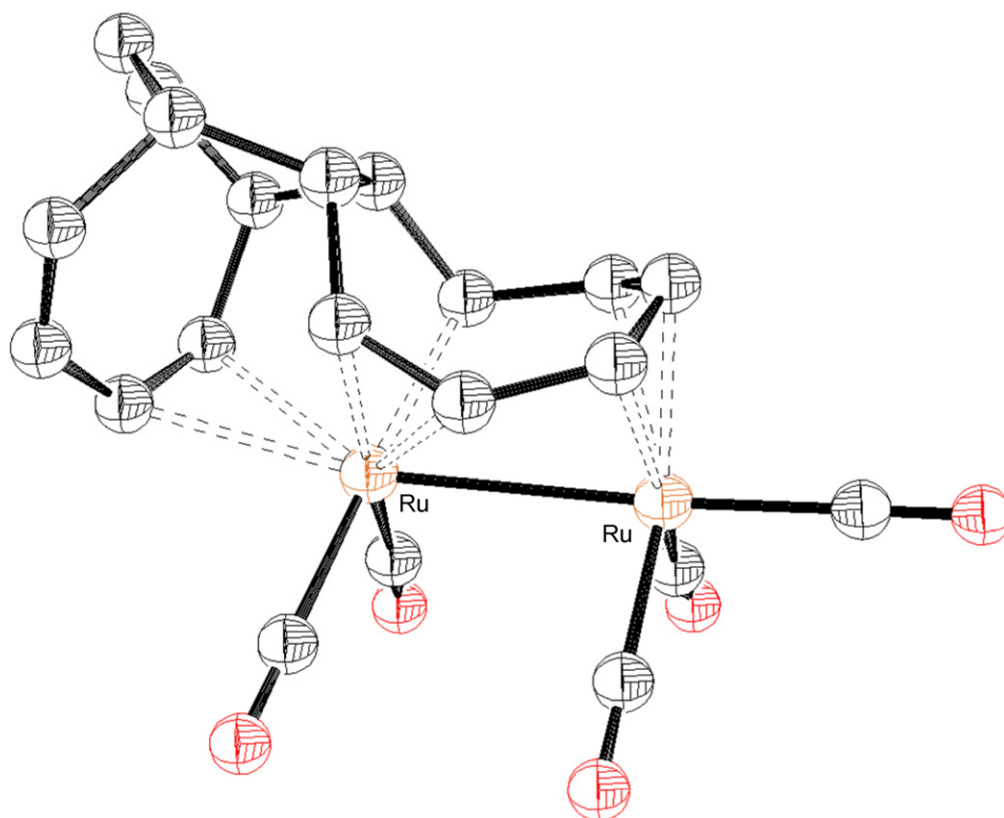
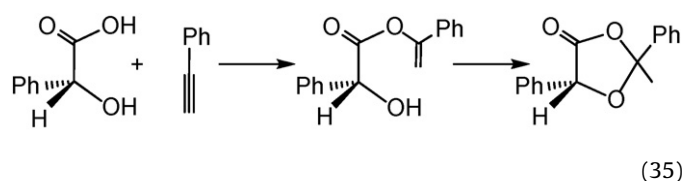
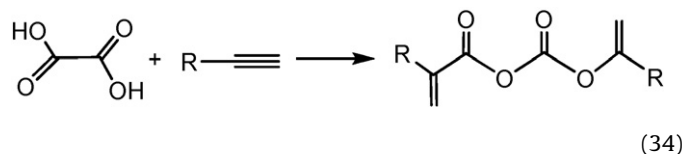

Fig. 28. Molecular structure of the complex $\text{Ru}_2(\text{CO})_5(\text{C}_{16}\text{H}_{16})$ [90].



This reaction principle has also been extended to diacids, giving dialk-1-en-2-yl oxalates [Eq. (34)] [109] and to α -hydroxy acids, giving enol esters (in tetrahydrofuran) that undergo spontaneous cyclization to 1,3-dioxolan-4-ones in toluene according

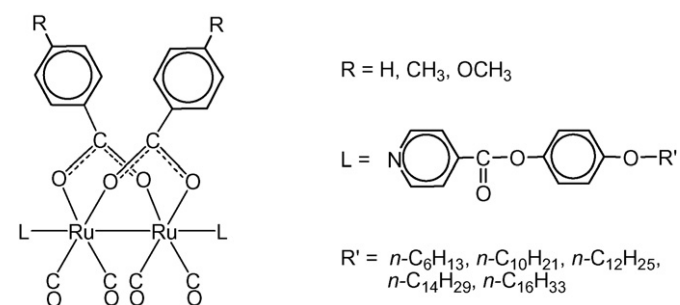
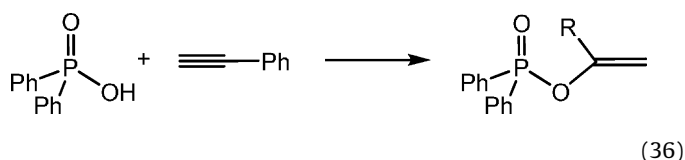

Fig. 29. Mesomorphic $\text{Ru}_2(\text{CO})_4(\text{OOC-}p\text{-C}_6\text{H}_4\text{R})_2\text{L}_2$ complexes containing mesogenic pyridine ligands in the axial positions [13].

to Eq. (35) [110]; all these transformations are catalyzed by $\text{Ru}_2(\text{CO})_4(\text{OOCH})_2(\text{PPh}_3)_2$ (catalyst/acid/alkyne 1:500:500, 100°C).

A similar reaction has been reported for the coupling of terminal alkynes with diphenylphosphinic acid leading to alkenyl diphenylphosphinates [Eq. (36)]; the reaction is catalyzed in toluene at 140°C by the precursor $\text{Ru}_3(\text{CO})_{12}$ or by $[\text{Ru}_2(\text{CO})_4(\text{OOPPh}_2)_2]_n$, isolated from the reaction mixture [111]



A number of carbon-carbon coupling reactions involving diazo compounds has been reported to be catalyzed by various diruthenium tetracarbonyl complexes. The diastereoselective *syn*-cyclopropanation of olefins with diazo acetate [112,113], according to Eq. (37), or with silylated diazo esters [114] is catalyzed by the $[\text{Ru}_2(\text{CO})_4(\text{OOCMe})_2]_n$ polymer or the complex

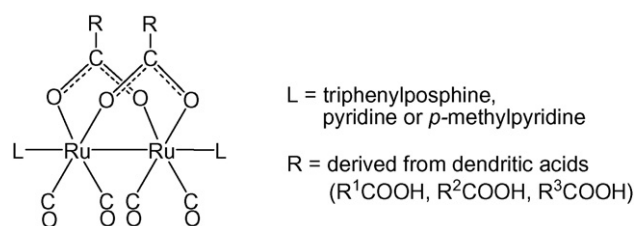

Fig. 30. Mesomorphic $\text{Ru}_2(\text{CO})_4(\text{OOCR})_2\text{L}_2$ complexes containing mesogenic dendritic substituents in the carboxylato bridges [14].

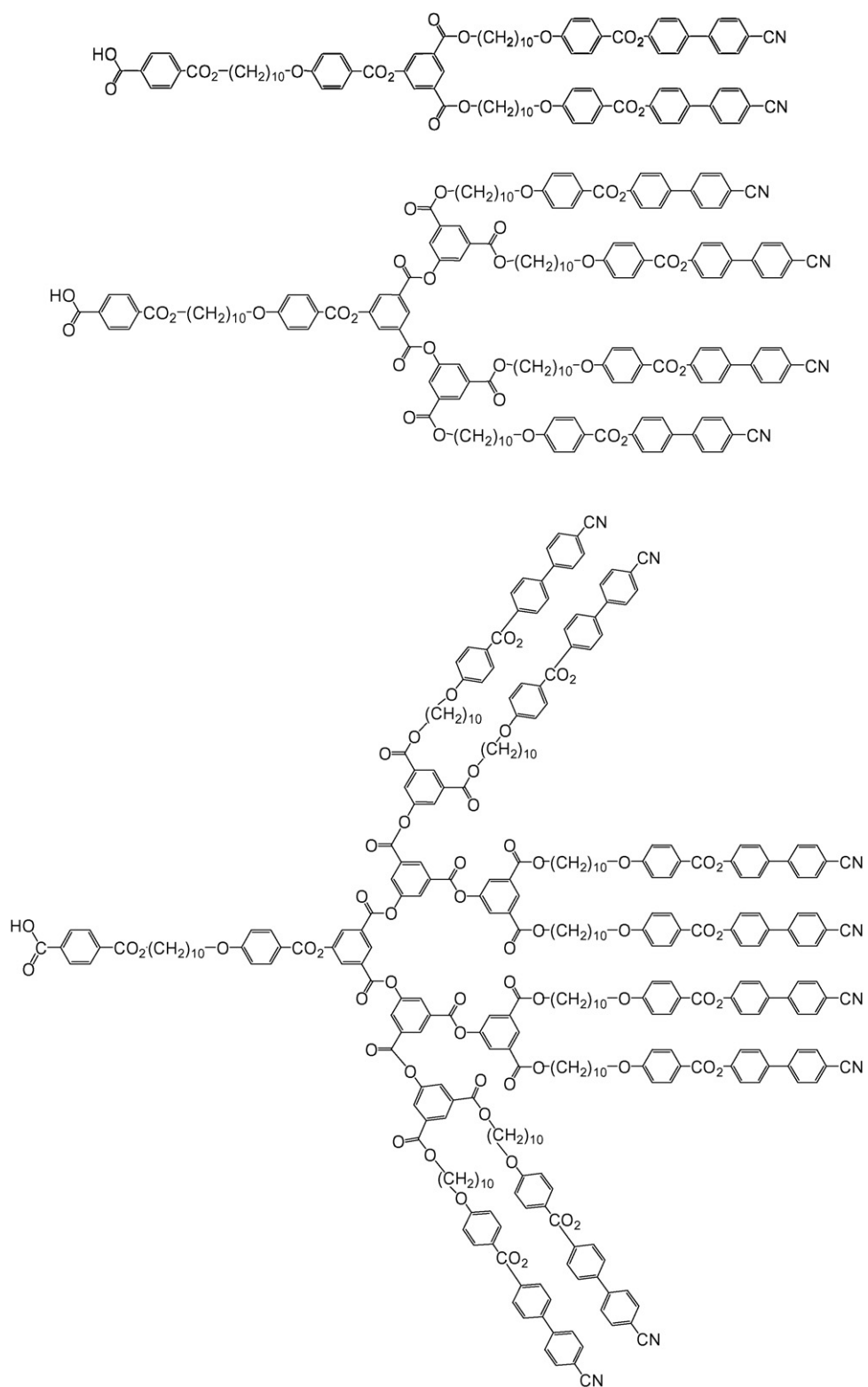

Fig. 31. The three generations of dendritic acids (R¹COOH, R²COOH, R³COOH) used for the synthesis of the mesomorphic metallodendrimer complexes Ru₂(CO)₄(OOCR)₂L₂ [14].

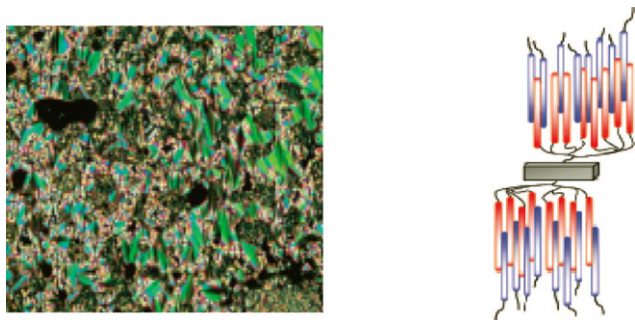
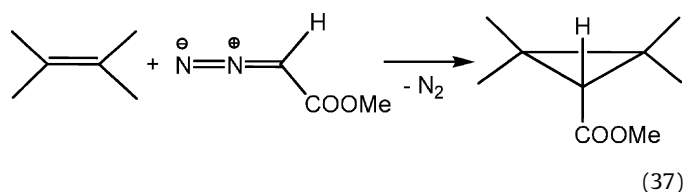
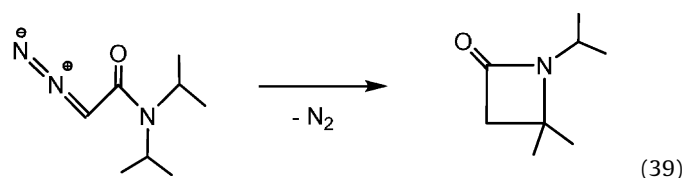
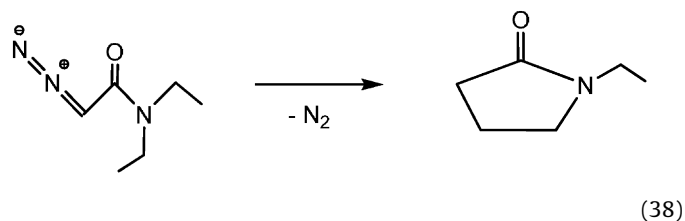

Fig. 32. Thermal optical micrograph of $\text{Ru}_2(\text{CO})_4(\text{OOCR}^3)_2(\text{PPh}_3)_2$ in the smectic A phase at 147 °C (left) and proposed supramolecular organization (right) [14].



In addition to $[\text{Ru}_2(\text{CO})_4(\text{OOCMe})_2]_n$ and $\text{Ru}_2(\text{CO})_4(\text{OOCMe})_2(\text{NCMe})_2$, the analogous pyridonato complexes $[\text{Ru}_2(\text{CO})_4(\text{Opy})_2]_n$ and $\text{Ru}_2(\text{CO})_4(\text{Opy})_2(\text{NCMe})_2$ (Opy = ONC_5H_4) as well as derivatives thereof have also been studied as catalysts for cyclopropanation reactions [115]



The saccharinato complexes $\text{Ru}_2(\text{CO})_4(\text{sac})_2(\text{PPh}_3)_2$, $\text{Ru}_2(\text{CO})_6(\text{sac})_2$, $\text{Ru}_2(\text{CO})_5(\text{sac})_2(\text{PPh}_3)$ and $\text{Ru}_2(\text{CO})_4(\text{sac})_2(\text{NCMe})_2$ (sac = $\text{C}_7\text{H}_4\text{NO}_3\text{S}$) also catalyze cyclopropanation reaction with diazo acetates [116]. The same diruthenium tetracarbonyl complexes, especially $[\text{Ru}_2(\text{CO})_4(\text{OOCMe})_2]_n$ have been found to catalyze in dichloromethane the intramolecular degradation of α -diazo acetamides to give lactams [Eqs. (38) and (39)], depending on the substituents in the amido function [117].

9. Mesomorphic $\text{Ru}_2(\text{CO})_4$ complexes

A century after their discovery, liquid crystals have stimulated an unrivalled development in the technology of mobile telephones, notebook computers and television screens. Today, liquid crystal displays (LCD) are essential parts of all types of electronic equipment. With the rapidly growing interest in this field, special attention has been paid to metallomesogens, which combine the properties of metal complexes (color, polarizability, magnetism and redox behavior) with those of anisotropic fluids. Because of their stability and their ligand variability, sawhorse-type diruthenium

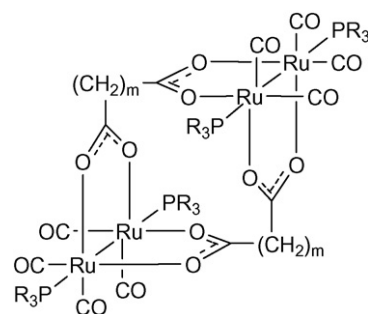

Fig. 33. Molecular loop arrangement in the $\text{Ru}_4(\text{CO})_8[\text{OOC}(\text{CH}_2)_m\text{COO}]_2(\text{PR}_3)_4$ macrocycles ($m = 1, 2, 3, 4$) [11,44,118,119].

tetracarbonyl complexes have been amongst the first metallomesogens containing a metal-metal bond.

Calamitic liquid crystals were obtained thanks to mesogenic pyridine ligands. The complexes $\text{Ru}_2(\text{CO})_4(\text{OOC}-p\text{-C}_6\text{H}_4\text{R})_2\text{L}_2$, containing aryl substituents ($\text{R} = \text{H}, \text{CH}_3, \text{OCH}_3$) in the carboxylato bridges and the pyridines ($\text{L} = p\text{-NC}_5\text{H}_4(p\text{-CO}_2-p\text{-C}_6\text{H}_4\text{OR}'$, $\text{R}' = \text{C}_6\text{H}_{13}, \text{C}_{10}\text{H}_{21}, \text{C}_{12}\text{H}_{25}, \text{C}_{14}\text{H}_{29}, \text{C}_{16}\text{H}_{33}$) in the axial positions (Fig. 29) are mesomorphic and display a nematic phase, which is enantiotropic in most cases but monotropic for the two combinations $\text{R} = \text{OCH}_3$, $\text{R}' = \text{C}_6\text{H}_{13}$ and $\text{R} = \text{OCH}_3$, $\text{R}' = \text{C}_{16}\text{H}_{33}$ [13].

On the other hand, mesomorphic metallodendrimers were obtained by introducing dendritic substituents into the carboxylato bridges. The complexes $\text{Ru}_2(\text{CO})_4(\text{OOCR})_2\text{L}_2$, containing the first, second and third generation dendrons R^1 , R^2 and R^3 , derived from the corresponding dendritic polyarylester carboxylic acids RCOOH ($\text{R} = \text{R}^1, \text{R}^2, \text{R}^3$, see Figs. 30 and 31), in the carboxylato bridges and simple phosphines or pyridines ($\text{L} = \text{PPh}_3, \text{py}, 4\text{-Me-py}$) in the axial positions give rise to the formation of a smectic A phase and, in the cases of the pyridine derivatives ($\text{L} = \text{py}, 4\text{-Me-py}$) to the formation of an additional nematic phase. The supramolecular organization of the third generation derivative containing $\text{R} = \text{R}^3$, $\text{L} = \text{PPh}_3$ in the smectic A phase was analyzed by X-ray diffraction; the proposed organization is shown in Fig. 32 [14].

10. Macrocyclic $\text{Ru}_2(\text{CO})_4$ complexes

The reaction of $\text{Ru}_3(\text{CO})_{12}$ with dicarboxylic acid leads, after addition of the corresponding axial ligands (L), to cage-like macrocycles, tetranuclear loops, hexanuclear triangles or octanuclear squares, depending on the nature of the dicarboxylato spacers. Interestingly, the type of cages obtained is not in line with the length of the spacer between the two carboxylic functions, thus giving rise to unpredictable structures.

Bianchi et al. were the first to show that the reaction of a polymer obtained from $\text{Ru}_3(\text{CO})_{12}$ and glutaric acid with tributylphosphine gives rise to the formation of the macrocyclic compound $\text{Ru}_4(\text{CO})_8[\text{OOC}(\text{CH}_2)_3\text{COO}]_2(\text{PBu}^n)_4$ (Fig. 34) [11]; the analogous reaction with succinic and adipic acids gives $\text{Ru}_4(\text{CO})_8[\text{OOC}(\text{CH}_2)_m\text{COO}]_2(\text{PBu}^n)_4$ ($m = 2$ and 4) see Fig. 33 [44]. The thermal reaction of $\text{Ru}_3(\text{CO})_{12}$ with malonic acid ($n = 1$) in tetrahydrofuran, followed by reaction with trimethylphosphine yields $\text{Ru}_4(\text{CO})_8[\text{OOCCH}_2\text{COO}]_2(\text{PMe}_3)_4$, the single-crystal X-ray analysis of which also revealed a macrocycle qualified as molecular loop [118] (Fig. 33).

The thermal reaction of $\text{Ru}_3(\text{CO})_{12}$ with tartaric acid, however, leads to the formation of a hexanuclear molecular triangle, which can be isolated as the triphenylphosphine or the acetonitrile derivatives $\text{Ru}_6(\text{CO})_{12}[\text{OOC}(\text{CHOH})_2\text{COO}]_3\text{L}_6$ ($\text{L} = \text{PPh}_3, \text{MeCN}$). The single-crystal X-ray structure analysis of the latter reveals three

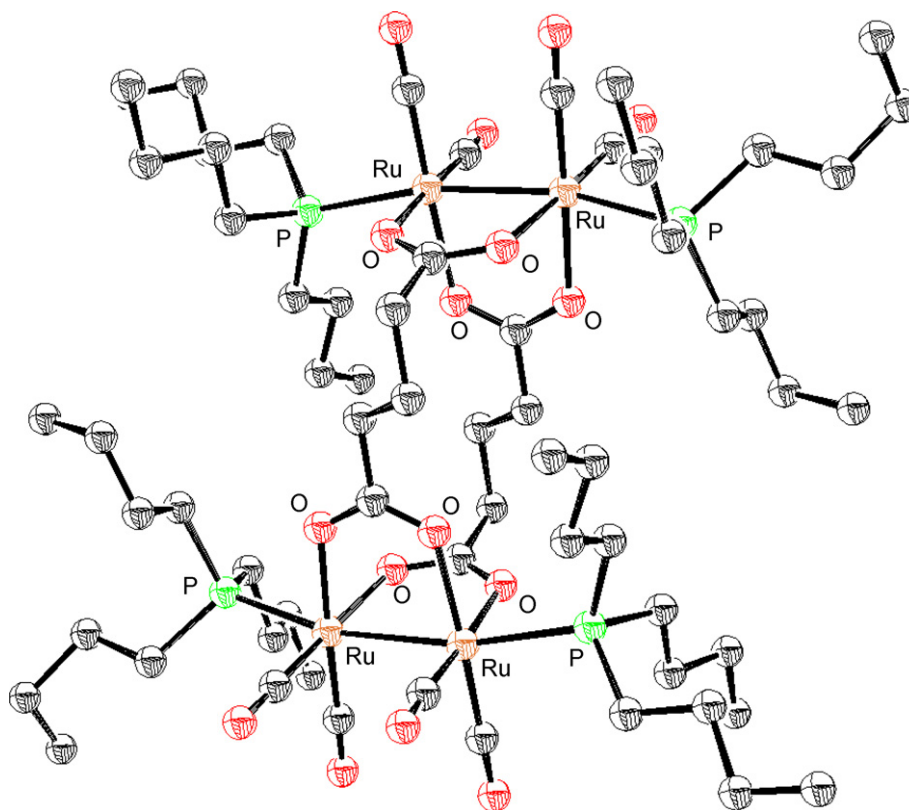

Fig. 34. Molecular structure of $\text{Ru}_4(\text{CO})_8[\text{OOC}(\text{CH}_2)_3\text{COO}]_2(\text{PBu}^n_3)_4$ [11].

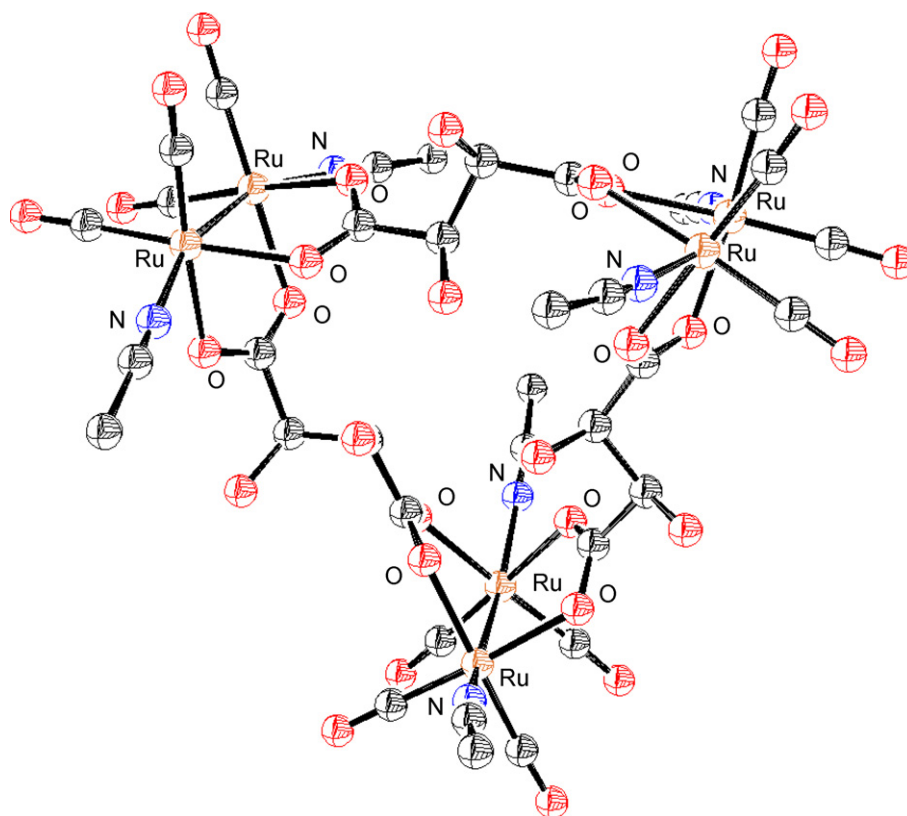

Fig. 35. Molecular structure of $\text{Ru}_6(\text{CO})_{12}[\text{OOC}(\text{CHOH})_2\text{COO}]_3(\text{NCMe})_6$ [119].

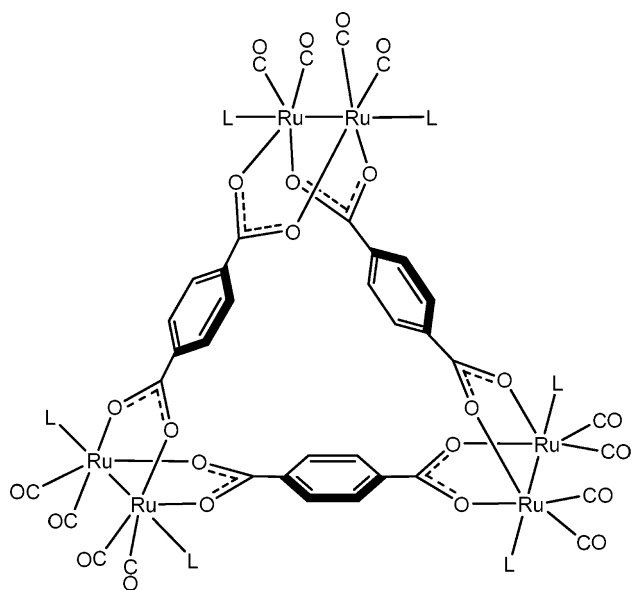

Fig. 36. Molecular triangle arrangement in Ru₆(CO)₁₂(OOCC₆H₄COO)₂L₆ [120].

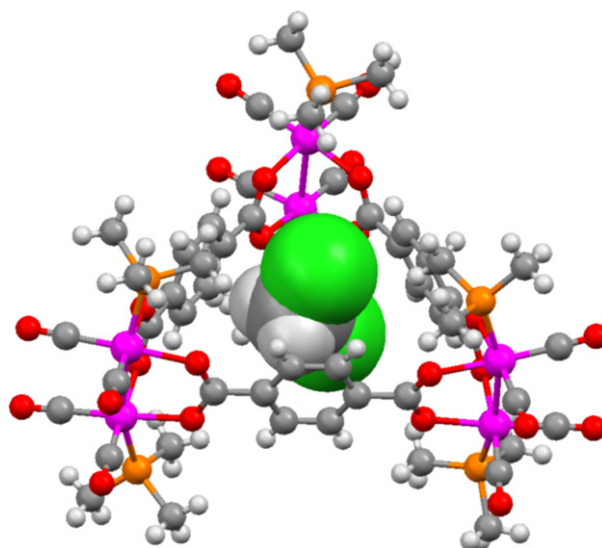

Fig. 37. Molecular structure of [CH₂Cl₂·Ru₆(CO)₁₂(OOCC₆H₄COO)₂(PMe₃)₆] [120].

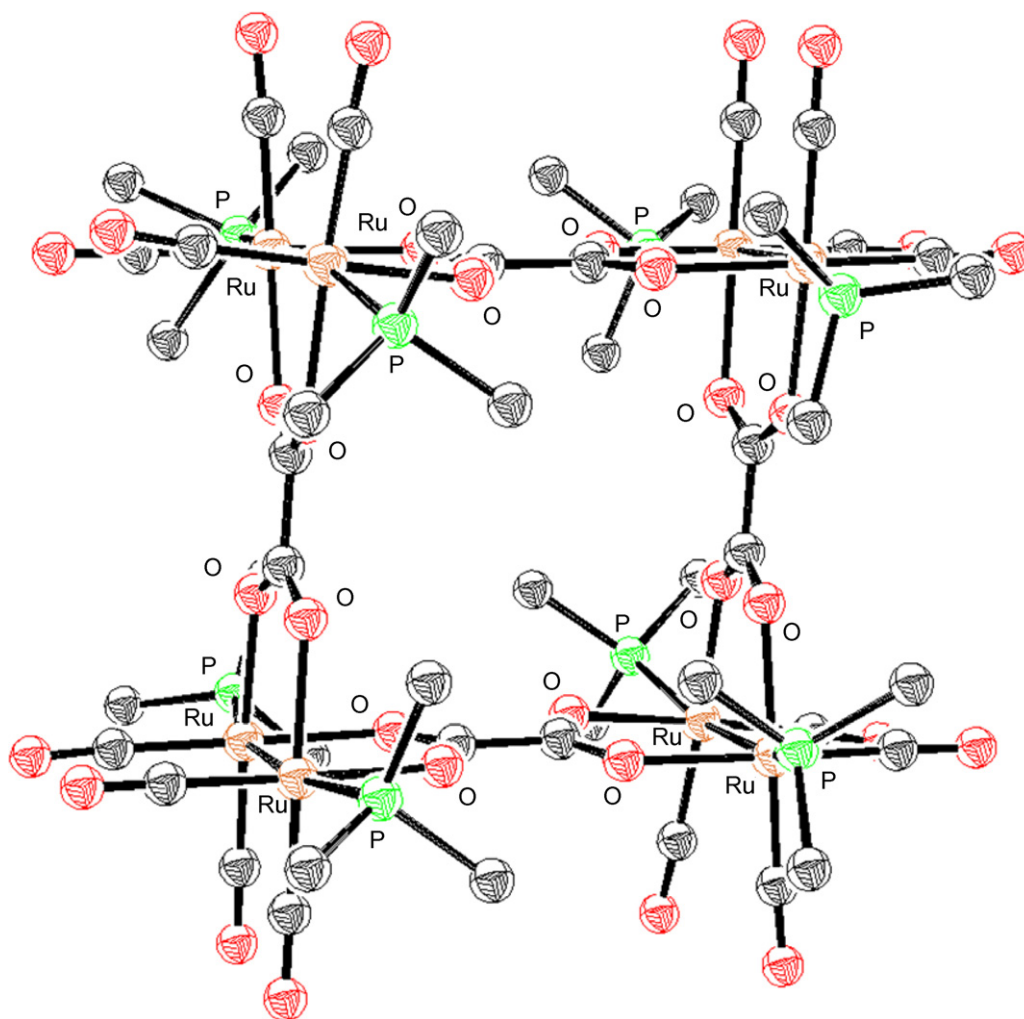

Fig. 38. Molecular structure of Ru₈(CO)₁₆(OOCCOO)₄(PMe₃)₈ [118].

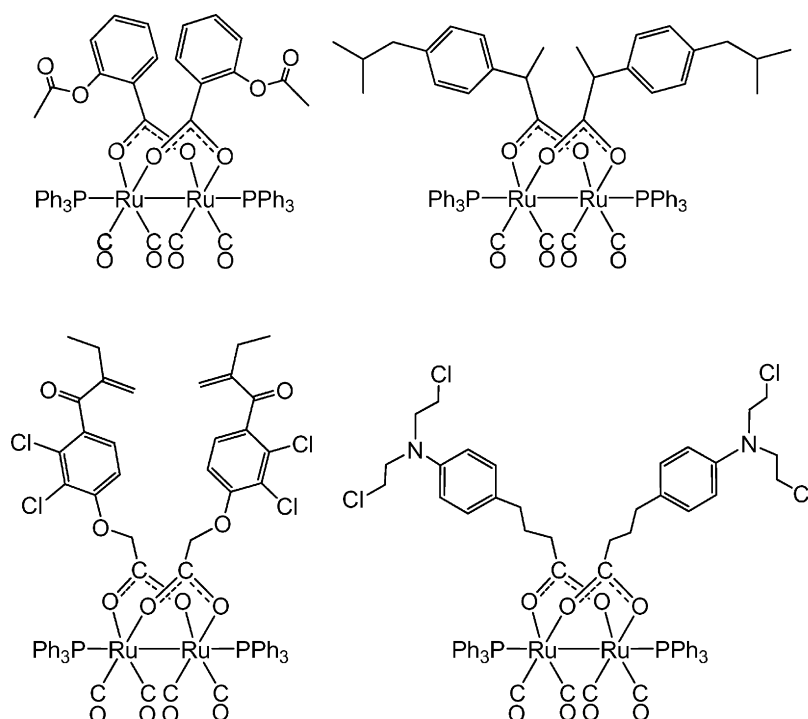

Fig. 39. $\text{Ru}_2(\text{CO})_4$ dicarboxylato complexes derived from acetyl salicylic acid [139], α -methyl-4-(isobutyl)-phenylacetic acid [139], ethacrynic acid [23] and 4-[bis(2-chorethyl)amino]benzenebutanoic acid [23].

$\text{Ru}_2(\text{CO})_4$ units to be coupled together by three tartrato bridges to give a tricycle (Fig. 35); the all-*R,R*, all-*S,S* and all-*R,S* diastereomers have been isolated [119].

Similar molecular triangles are obtained using terephthalic acid [120] or 4,4'-diphenyldicarboxylic acid [104] as dicarboxylato spacers, see Fig. 36. The hexanuclear macrocycle $\text{Ru}_6(\text{CO})_{12}(\text{OOC}_6\text{H}_4\text{COO})_3(\text{PPh}_3)_6$, which has a cavity of $11.1 \text{ \AA} \times 11.1 \text{ \AA} \times 11.1 \text{ \AA}$, can accommodate a CH_2Cl_2 molecule in the hollow space of the triangle, see Fig. 37 and crystallizes as dichloromethane adduct [120].

The reaction of $\text{Ru}_3(\text{CO})_{12}$ with oxalic acid in thf at 120°C produces the oxalato-bridged polymer $[\text{Ru}_2(\text{CO})_4(\text{OOCOO})]_n$, which reacts with trimethylphosphine to give the octanuclear macrocycle $\text{Ru}_8(\text{CO})_{16}(\text{OOCOO})_4(\text{PMe}_3)_8$. The molecular structure of this macrocycle, confirmed by X-ray structure analysis, can be described as a molecular square formed by four $\text{Ru}_2(\text{CO})_4$ units connected by four oxalato bridges, see Fig. 38 [118].

The supramolecular self-assembly of the hexanuclear macrocycle $\text{Ru}_6(\text{CO})_{12}(\text{OOC}_6\text{H}_4\text{C}_6\text{H}_4\text{COO})_3(\text{PPh}_3)_6$ is interesting. The molecules are arranged in a hexagonal closed packing due to non-

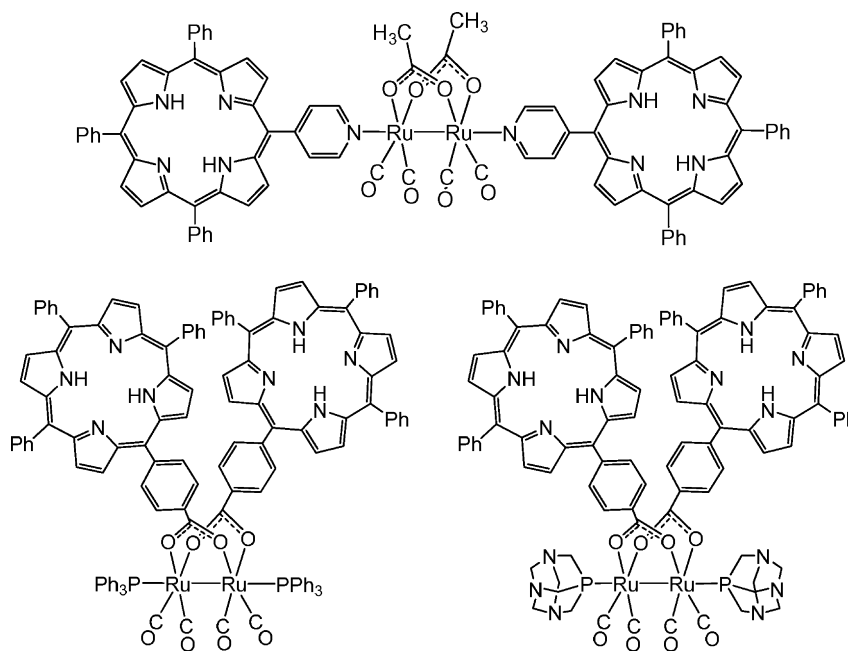

Fig. 40. $\text{Ru}_2(\text{CO})_4$ dicarboxylato complexes derived from porphyrin [140].

covalent π - π interactions of the phenyl groups, giving rise to one-dimensional trigonal channels (cavity of $15.3 \text{ \AA} \times 15.3 \text{ \AA} \times 15.3 \text{ \AA}$) that can accommodate guest molecules such as methanol and dichloromethane; this superstructure has been described as "molecular zeolite" [121]. The supramolecular ordering of the octanuclear macrocycle $\text{Ru}_8(\text{CO})_{16}(\text{OOCOO})_4(\text{PMe}_3)_8$, which has a square cavity of $4.7 \text{ \AA} \times 4.7 \text{ \AA}$ capable to host a CH_2Cl_2 molecule [118], on graphite to give highly two-dimensional arrays was studied by scanning tunnelling microscopy [122,123].

11. Biologically active $\text{Ru}_2(\text{CO})_4$ complexes

Of all chemotherapeutic metals, ruthenium is considered to be the most promising one, it is seen by many as being the best substitute for platinum in cancer therapy [124–127]. As it has properties similar to those of the essential element iron and can be metabolized in same way is of particular importance [128,129]. Pioneered by P.J. Sadler, B.K. Keppler and P. J. Dyson, several ruthenium compounds are in clinical trials [130,131]. Whereas metal carbonyl complexes have not been considered as therapeutics for a long time due to the notorious toxicity of carbon monoxide, nickel tetracarbonyl and iron pentacarbonyl, the situation changed, when it became clear that CO, formed in mammalian cells via the oxidation of hemes by the enzyme heme oxygenase, plays a critical role in the resolution of inflammatory processes and alleviation of cardiovascular disorders [132]. As a consequence, CO gas and several metal carbonyl derivatives are currently under investigation for the prevention vascular dysfunction, inflammation as well as tissue, ischemia and organ rejection [132,133]. Moreover, carbonyl complexes of rhenium and technetium have recently been considered for radiopharmaceutical applications in cancer diagnosis and therapy [134]. Among other family of ruthenium complexes, carbonyl derivatives are slowly getting more attention and studies dealing with anticancer activity of ruthenium carbonyl clusters have been recently published [135–138].

As far as sawhorse-type diruthenium tetracarbonyl complexes are concerned, carboxylato-bridged $\text{Ru}_2(\text{CO})_4$ compounds derived from biologically active acids such as acetyl salicylic acid (Aspirin[®]) [139], α -methyl-4-(isobutyl)-phenylacetic acid (Ibuprofen[®]) [139], ethacrynic acid [23] and 4-[bis(2-chorethyl)amino]benzenebutanoic acid (chlorambucil) [23] have been reported, see Fig. 39. However, these complexes showed no cytotoxicity towards human ovarian cancer cells, presumably due to their low solubility in water.

By contrast, the porphyrin-derived diruthenium tetracarbonyl complexes $\text{Ru}_2(\text{CO})_4(\text{OOCMe})_2$ [$L = 5$ -(4-pyridyl)-10,15,20-triphenyl,21,23H-porphyrin] and $\text{Ru}_2(\text{CO})_4(\text{OOCR})_2$ [$R = 5$ -(4-phenyl)-10,15,20-triphenyl,21,23H-porphyrin, $L' =$ triphenylporphyrine or 1,3,5-triaza-7-phosphatricyclo[3.3.1.1]decane} (Fig. 40) were found to be highly selective photosensitizers for female reproductive cancer cells. The cytotoxicities of these complexes have been studied in human normal fibroblasts and in several human cancer cell lines. They display no cytotoxicity in the dark for concentrations up to $100 \mu\text{M}$ and for all the cell lines tested [140].

Interestingly, uptake studies revealed that the complexes are only taken up by human HeLa cervix and A2780 ovarian carcinoma cell lines and not by the other human normal or cancer cell lines. Fluorescent microscopy studies also demonstrated that the complexes are taken up by HeLa, Ovar and A2780 cells and concentrate in the cell cytoplasm and organelles, but not in the nucleus. Photodynamic studies provided coherent results as compared to the uptake studies, since these complexes induce phototoxicities in HeLa cervix and A2780 ovarian carcinoma cell lines and not in other cancer and normal fibroblast cells. Moreover, the complexes

appeared to be efficient since they are active at low concentration ($2.5 \mu\text{M}$) and at low dose of light ($1.5 < \text{LD}_{50} < 6.5 \text{ J/cm}^2$). Thus, these new complexes are efficient photosensitizers and could provide new hints for the design of compounds specific for cancers of female reproductive system that do not target normal cells [140].

12. Outlook

Dinuclear ruthenium complexes containing a $\text{Ru}_2(\text{CO})_4$ backbone with a typical sawhorse geometry also have two three-electron bridges and two terminal two-electron ligands, which can both be easily modified. Thus, complexes of this type proved to provide a stable, versatile and tunable platform for the design of molecular catalysts, liquid crystals, supramolecular materials as well as of bioactive substances.

Acknowledgements

Continuous financial support by the Swiss National Science Foundation and generous loans of ruthenium trichloride hydrate by the Johnson Matthey Technology Centre are gratefully acknowledged.

References

- [1] G.R. Crooks, B.F.G. Johnson, J. Lewis, I.G. Williams, G. Gamlen, *J. Chem. Soc. (A)* (1969) 2761.
- [2] H. Schumann, J. Opitz, J. Pickardt, *J. Organomet. Chem.* 128 (1977) 253.
- [3] T.A. Bright, R.A. Jones, C.M. Nunn, *J. Coord. Chem.* 18 (1988) 361.
- [4] M.I. Bruce, B.W. Skelton, A.H. White, N.N. Zaitseva, *Aust. J. Chem.* 52 (1999) 621.
- [5] L. Xu, Y. Sasaki, *J. Organomet. Chem.* 585 (1999) 246.
- [6] G. Süß-Fink, G. Herrmann, P. Morys, J. Ellermann, A. Veit, *J. Organomet. Chem.* 284 (1985) 263.
- [7] M. Spohn, T. Vogt, J. Strähle, *Z. Naturforsch.* 41b (1986) 1373.
- [8] M. Spohn, J. Strähle, W. Hiller, *Z. Naturforsch.* 41b (1986) 541.
- [9] M.A. Petrukhina, Y. Sevryugina, K.W. Andreini, *J. Cluster Sci.* 15 (2004) 451.
- [10] M. Rotem, Y. Shvo, I. Goldberg, U. Shmueli, *Organometallics* 3 (1984) 1758.
- [11] M. Bianchi, U. Matteoli, P. Frediani, F. Piacenti, U. Nardelli, G. Pelizzi, *Chim. Ind. (Milan)* 63 (1981) 475.
- [12] R. Dorta, G. Süß-Fink, H. Stöckli-Evans, *Acta Cryst.* E60 (2004) m1397.
- [13] R. Deschenaux, B. Donnio, G. Rheinwald, F. Stauffer, G. Süß-Fink, J. Velker, *J. Chem. Soc., Dalton Trans.* (1997) 4351.
- [14] S. Frein, M. Auzias, A. Sondenecker, L. Vieille-Petit, B. Guintchin, N. Maringa, G. Süß-Fink, J. Barberá, R. Deschenaux, *Chem. Mater.* 20 (2008) 1340.
- [15] J.-L. Wolfender, F. Neumann, G. Süß-Fink, *J. Organomet. Chem.* 389 (1990) 351.
- [16] F. Neumann, H. Stöckli-Evans, G. Süß-Fink, *J. Organomet. Chem.* 379 (1989) 139.
- [17] M. Auzias, B. Therrien, G. Süß-Fink, *Acta Cryst.* E61 (2005) m2426.
- [18] F. Neumann, H. Stöckli-Evans, G. Süß-Fink, *J. Organomet. Chem.* 379 (1989) 151.
- [19] F. Neumann, G. Süß-Fink, *J. Organomet. Chem.* 367 (1989) 175.
- [20] M. Langenbahn, H. Stöckli-Evans, G. Süß-Fink, *J. Organomet. Chem.* 397 (1990) 347.
- [21] G. Rheinwald, H. Stöckli-Evans, G. Süß-Fink, *J. Organomet. Chem.* 441 (1992) 295.
- [22] M. Auzias, B. Therrien, G. Labat, H. Stöckli-Evans, G. Süß-Fink, *Inorg. Chim. Acta* 359 (2006) 1012.
- [23] M. Auzias, J. Mattsson, B. Therrien, G. Süß-Fink, *Z. Anorg. Allg. Chem.* 635 (2009) 115.
- [24] M. Bianchi, G. Menchi, F. Francalanci, F. Piacenti, U. Matteoli, P. Frediani, C. Botteghi, *J. Organomet. Chem.* 188 (1980) 109.
- [25] C.M. Kepert, G.B. Deacon, L. Spiccia, G.D. Fallon, B.W. Skelton, A.H. White, *J. Chem. Soc., Dalton Trans.* (2000) 2867.
- [26] P.A. Anderson, G.B. Deacon, K.H. Haarmann, F.R. Keene, T.J. Meyer, D.A. Reitsma, B.W. Skelton, G.F. Strouse, N.C. Thomas, J.A. Treadway, A.H. White, *Inorg. Chem.* 34 (1995) 6145.
- [27] J.S. Field, R.J. Haines, C.J. Parry, *J. Chem. Soc., Dalton Trans.* (1997) 2843.
- [28] G. Süß-Fink, F. Neumann, unpublished, cf. F. Neumann, Ph.D. Thesis, Aachen University of Technology, (RWTH Aachen), 1990.
- [29] M. Rotem, I. Goldberg, U. Shmueli, Y. Shvo, *J. Organomet. Chem.* 314 (1986) 185.
- [30] B.F.G. Johnson, R.D. Johnston, J. Lewis, I.G. Williams, *J. Chem. Soc. (A)* (1971) 689.

- [31] U. Matteoli, G. Menchi, P. Frediani, M. Bianchi, F. Piacenti, *J. Organomet. Chem.* 285 (1985) 281.
- [32] S.J. Sherlock, M. Cowie, E. Singleton, M.M. de, V. Steyn, *Organometallics* 7 (1988) 1663.
- [33] G.F. Schmidt, G. Süß-Fink, *J. Organomet. Chem.* 362 (1989) 179.
- [34] R.W. Hiltz, S.J. Sherlock, M. Cowie, E. Singleton, M.M. de, V. Steyn, *Inorg. Chem.* 29 (1990) 3161.
- [35] P. Frediani, M. Bianchi, A. Salvini, R. Guarducci, L.C. Carluccio, F. Piacenti, S. Ianelli, M. Nardelli, *J. Organomet. Chem.* 463 (1993) 187.
- [36] P. Frediani, C. Gianelli, A. Salvini, S. Ianelli, *J. Organomet. Chem.* 667 (2003) 197.
- [37] P. Pearson, C.M. Kepert, G.B. Deacon, L. Spiccia, A.C. Warden, B.W. Skelton, A.H. White, *Inorg. Chem.* 43 (2004) 683.
- [38] M. Auzias, B. Therrien, G. Süß-Fink, P. Štěpnička, J. Ludvíč, *J. Organomet. Chem.* 692 (2007) 755.
- [39] P. Frediani, M. Bianchi, A. Salvini, F. Piacenti, *J. Chem. Soc., Dalton Trans.* (1990) 3663.
- [40] P. Frediani, C. Faggi, S. Papaleo, A. Salvini, M. Bianchi, F. Piacenti, S. Ianelli, M. Nardelli, *J. Organomet. Chem.* 536–537 (1997) 123.
- [41] P. Frediani, C. Faggi, A. Salvini, M. Bianchi, F. Piacenti, *Inorg. Chim. Acta* 272 (1998) 141.
- [42] F. Micoli, L. Salvi, A. Salvini, P. Frediani, C. Giannelli, *J. Organomet. Chem.* 690 (2005) 4867.
- [43] H. Schumann, J. Opitz, *Chem. Ber.* 113 (1980) 989.
- [44] M. Bianchi, P. Frediani, U. Matteoli, G. Menchi, F. Piacenti, G. Petrucci, *J. Organomet. Chem.* 259 (1983) 207.
- [45] M. Bianchi, G. Menchi, P. Frediani, F. Piacenti, A. Scrivanti, U. Matteoli, *J. Mol. Catal.* 50 (1989) 277.
- [46] J.A. Cabeza, C. Landazuri, L.A. Oro, A. Tiripicchio, M. Tiripicchio-Camellini, *J. Organomet. Chem.* 322 (1987) C16.
- [47] S.J. Sherlock, M. Cowie, E. Singleton, M.M. de, V. Steyn, *J. Organomet. Chem.* 361 (1989) 353.
- [48] Y.-H. Song, Y. Chi, Y.-L. Chen, C.-S. Liu, W.-L. Ching, A.J. Carty, S.-M. Peng, G.-H. Lee, *Organometallics* 21 (2002) 4735.
- [49] S. García-Granda, R. Obeso-Rosete, J.M. Rubio-González, A. Anillo, *Acta Cryst.* C46 (1990) 2043.
- [50] J.A. Cabeza, J.M. Fernández-Colinas, *Coord. Chem. Rev.* 126 (1993) 319.
- [51] S.F. Colson, S.D. Robinson, *Polyhedron* 7 (1988) 417.
- [52] B.R. Cockerton, A.J. Deeming, *J. Organomet. Chem.* 426 (1992) C36.
- [53] P.L. Andreu, J.A. Cabeza, V. Riera, Y. Jeannin, D. Miguel, *J. Chem. Soc., Dalton Trans.* (1990) 2201.
- [54] P.L. Andreu, J.A. Cabeza, J.M. Fernández-Colinas, V. Riera, *J. Chem. Soc., Dalton Trans.* (1990) 2927.
- [55] P.L. Andreu, J.A. Cabeza, G.A. Carriedo, V. Riera, S. García-Granda, J.F. Van der Maelen, G. Mori, *J. Organomet. Chem.* 421 (1991) 305.
- [56] L. Schäffler, U.R. Werz, G. Maas, *Inorg. Chim. Acta* 358 (2005) 3152.
- [57] L. Schäffler, B. Müller, G. Maas, *Inorg. Chim. Acta* 359 (2006) 970.
- [58] J.A. Cabeza, I. del Río, V. Riera, M. Suárez, C. Álvarez-Rúa, S. García-Granda, S.H. Chuang, J.R. Hwu, *Eur. J. Inorg. Chem.* (2003) 4159.
- [59] P.L. Andreu, J.A. Cabeza, V. Riera, F. Robert, Y. Jeannin, *J. Organomet. Chem.* 372 (1989) C15.
- [60] S. Jeannin, Y. Jeannin, G. Lavigne, *Trans. Met. Chem.* 1 (1976) 186.
- [61] J.A. Cabeza, M.A. Martínez-García, V. Riera, S. García-Granda, J.F. van der Maelen, *J. Organomet. Chem.* 514 (1996) 197.
- [62] B.F.G. Johnson, R.D. Johnston, P.L. Josty, J. Lewis, I.G. Williams, *Nature* 213 (1967) 901.
- [63] K. Seitz, U. Behrens, *J. Organomet. Chem.* 345 (1988) 351.
- [64] J.A. Cabeza, M.A. Martínez-García, V. Riera, D. Ardura, S. García-Granda, *Organometallics* 17 (1998) 1471.
- [65] W.R. Cullen, A. Talaba, S.J. Rettig, *Organometallics* 11 (1992) 3152.
- [66] J.A. Cabeza, M.A. Martínez-García, V. Riera, D. Ardura, S. García-Granda, J.F. van der Maelen, *Eur. J. Inorg. Chem.* (1999) 1133.
- [67] A.K. Justice, R.C. Linck, T.B. Rauchfuss, S.R. Wilson, *J. Am. Chem. Soc.* 126 (2004) 13214.
- [68] A.K. Justice, R.C. Linck, T.B. Rauchfuss, *Inorg. Chem.* 45 (2006) 2406.
- [69] J.A. Cabeza, M.A. Martínez-García, V. Riera, D. Ardura, S. García-Granda, *Eur. J. Inorg. Chem.* (2000) 499.
- [70] S.E. Kabir, S.J. Ahmed, Md.I. Hyder, Md.A. Miah, D.W. Bennett, D.T. Haworth, T.A. Siddiquee, E. Rosenberg, *J. Organomet. Chem.* 689 (2004) 3412.
- [71] E.D. Schermer, W.H. Baddley, *J. Organomet. Chem.* 30 (1971) 67.
- [72] P.L. Andreu, J.A. Cabeza, D. Miguel, V. Riera, M.A. Villa, S. García-Granda, *J. Chem. Soc., Dalton Trans.* (1991) 533.
- [73] C.M. Barnes, D.S. Bohle, S.K. Madsen, *Inorg. Chem.* 33 (1994) 6411.
- [74] D.S. Bohle, H. Vahrenkamp, *Inorg. Chem.* 29 (1990) 1097.
- [75] G. Süß-Fink, G. Rheinwald, unpublished, cf. G. Rheinwald, Ph.D. Thesis, University of Neuchâtel, 1990.
- [76] A. Béguin, H.-C. Böttcher, M.C. Dai, G. Rheinwald, H. Stöckli-Evans, G. Süß-Fink, B. Walthert, *Chimia* 47 (1993) 192.
- [77] M.I. Bruce, G. Shaw, F.G.A. Stone, *J. Chem. Soc., Dalton Trans.* (1972) 2904.
- [78] K. Natarajan, G. Huttner, *Prod. Indian Acad. Sci.* 91 (1982) 507.
- [79] R.P. Rosen, G.L. Geoffroy, C. Bueno, M.R. Churchill, R.B. Ortega, *J. Organomet. Chem.* 254 (1983) 89.
- [80] R. Regragui, P.H. Dixneuf, N.J. Taylor, A.J. Carty, *Organometallics* 3 (1984) 1020.
- [81] V.D. Patel, A.A. Cherkas, D. Nucciarone, N.J. Taylor, A.J. Carty, *Organometallics* 4 (1985) 1792.
- [82] L.M. Bullock, J.S. Field, R.J. Haines, E. Minshall, M.H. Moore, F. Mulla, D.N. Smit, L.M. Steer, *J. Organomet. Chem.* 381 (1990) 429.
- [83] J.S. Field, R.J. Haines, F. Mulla, *J. Organomet. Chem.* 389 (1990) 227.
- [84] Z. He, N. Lujan, D. Neibecker, R. Mathieu, J.-J. Bonnet, *J. Organomet. Chem.* 426 (1992) 247.
- [85] J.P. Candlin, K.K. Joshi, D.T. Thompson, *Chem. Ind.* (1966) 1960.
- [86] B.E. Job, R.A.N. McLean, D.T. Thompson, *Chem. Commun.* (1966) 895.
- [87] F.A. Cotton, A. Davison, A. Musco, *J. Am. Chem. Soc.* 89 (1967) 6796.
- [88] F.A. Cotton, W.T. Edwards, *J. Am. Chem. Soc.* 90 (1968) 5412.
- [89] R. Goddard, A.P. Humphries, S.A.R. Knox, P. Woodward, *J. Chem. Soc., Chem. Commun.* (1975) 508.
- [90] R. Goddard, P. Woodward, *J. Chem. Soc., Dalton Trans.* (1979) 661.
- [91] A.P. Humphries, S.A.R. Knox, *J. Chem. Soc., Dalton Trans.* (1978) 1514.
- [92] M.J. Bennett, F.A. Cotton, P. Legzdins, *J. Am. Chem. Soc.* 89 (1967) 6797.
- [93] D.F. Gill, B.E. Mann, B.L. Shaw, *J. Chem. Soc., Dalton Trans.* (1973) 311.
- [94] R. Mason, K.M. Thomas, D.F. Gill, B.L. Shaw, *J. Organomet. Chem.* 40 (1972) C67.
- [95] H. Schumann, J. Opitz, *J. Pickardt, Chem. Ber.* 113 (1980) 1385.
- [96] A. Salvini, P. Frediani, F. Piacenti, *J. Mol. Catal. A* 159 (2000) 185.
- [97] A. Salvini, P. Frediani, C. Giannelli, L. Rosi, *J. Organomet. Chem.* 690 (2005) 371.
- [98] A. Salvini, P. Frediani, E. Rivalta, *Inorg. Chim. Acta* 351 (2003) 225.
- [99] P. Frediani, M. Bianchi, A. Salvini, R. Guarducci, L.C. Carluccio, F. Piacenti, *J. Organomet. Chem.* 498 (1995) 187.
- [100] J. Jenck, P. Kalck, E. Pinelli, M. Siani, A. Thorez, *J. Chem. Soc., Chem. Commun.* (1988) 1428.
- [101] U. Matteoli, M. Bianchi, G. Menchi, P. Frediani, F. Piacenti, *J. Mol. Catal.* 29 (1985) 269.
- [102] U. Matteoli, G. Menchi, M. Bianchi, F. Piacenti, *J. Organomet. Chem.* 299 (1986) 233.
- [103] U. Matteoli, G. Menchi, M. Bianchi, F. Piacenti, S. Ianelli, M. Nardelli, *J. Organomet. Chem.* 498 (1995) 177.
- [104] J.J. Byerley, G.L. Rempel, N. Takebe, B.R. James, *J. Chem. Soc.: Chem. Commun.* (1971) 1482.
- [105] I. Shimoyama, T. Hachiya, M. Mizuguchi, T. Nakamura, M. Kaihara, T. Ikariya, *J. Organomet. Chem.* 584 (1999) 197.
- [106] M. Langenbahn, H. Stöckli-Evans, G. Süß-Fink, *Helv. Chim. Acta* 74 (1991) 549.
- [107] M. Rotem, Y. Shvo, *Organometallics* 2 (1983) 1689.
- [108] P. Le Gendre, V. Comte, A. Michelot, C. Moise, *Inorg. Chim. Acta* 350 (2003) 289.
- [109] C. Bruneau, P.H. Dixneuf, *Chem. Commun.* (1997) 507.
- [110] M. Neveux, B. Seiller, F. Hagedorn, C. Bruneau, P.H. Dixneuf, *J. Organomet. Chem.* 451 (1993) 133.
- [111] R. Hua, M. Tanaka, *Chem. Lett.* (1998) 431.
- [112] G. Maas, T. Werle, M. Alt, D. Mayer, *Tetrahedron* 49 (1993) 881.
- [113] T. Werle, G. Maas, *Adv. Synth. Catal.* 343 (2001) 37.
- [114] G. Maas, M. Alt, D. Mayer, U. Bergsträsser, S. Sklenak, P. Xavier, Y. Apeloig, *Organometallics* 20 (2001) 4607.
- [115] T. Werle, L. Schäffler, G. Maas, *J. Organomet. Chem.* 690 (2005) 5562.
- [116] S. Buck, G. Maas, *J. Organomet. Chem.* 691 (2006) 2774.
- [117] M. Grohmann, S. Buck, L. Schäffler, G. Maas, *Adv. Synth. Catal.* 348 (2006) 2203.
- [118] K.-B. Shiu, H.-C. Lee, G.-H. Lee, Y. Wang, *Organometallics* 21 (2002) 4013.
- [119] G. Süß-Fink, J.-L. Wolfender, F. Neumann, H. Stöckli-Evans, *Angew. Chem. Int. Ed.* 29 (1990) 429.
- [120] M. Auzias, B. Therrien, G. Süß-Fink, *Inorg. Chem. Commun.* 10 (2007) 1420.
- [121] K.-B. Shiu, H.-C. Lee, G.-H. Lee, B.-T. Ko, Y. Wang, C.-C. Lin, *Angew. Chem. Int. Ed.* 42 (2003) 2999.
- [122] D.-L. Shieh, K.-B. Shiu, J.-L. Lin, *Eur. J. Inorg. Chem.* (2004) 2223.
- [123] D.-L. Shieh, K.-B. Shiu, J.-L. Lin, *Surf. Sci.* 548 (2004) L7.
- [124] M.J. Clarke, F. Zhu, D.R. Frasca, *Chem. Rev.* 99 (1999) 2511.
- [125] F. Wang, J. Xu, A. Habtemariam, J. Bella, P.J. Sadler, *J. Am. Chem. Soc.* 127 (2005) 17734.
- [126] P.J. Dyson, G. Sava, *Dalton Trans.* (2006) 1929.
- [127] C.G. Hartinger, P.J. Dyson, *Chem. Soc. Rev.* 38 (2009) 391.
- [128] Y.N. Vashisht Gopal, D. Jayaraju, A.K. Kondapi, *Biochemistry* 38 (1999) 4382.
- [129] I.W. McNae, K. Fishburne, A. Habtemariam, T.M. Hunter, M. Melchart, F. Wang, M.D. Walkinshaw, P.J. Sadler, *Chem. Commun.* (2004) 1786.
- [130] J.M. Rademaker-Lakhai, D. van den Bongard, D. Pluim, J.H. Beijnen, J.H.M. Schellens, *Clin. Cancer Res.* 10 (2004) 3717.
- [131] C.G. Hartinger, S. Zorbas-Seifried, M.A. Jakupec, B. Kynast, H. Zorbas, B.K. Keppler, *J. Inorg. Biochem.* 100 (2006) 891.
- [132] T.R. Johnson, B.E. Mann, J.E. Clark, R. Foresti, C.J. Green, R. Motterlini, *Angew. Chem. Int. Ed.* 42 (2003) 3722.
- [133] B.E. Mann, R. Motterlini, *Chem. Commun.* (2007) 4197.
- [134] G. Jaouen, S. Top, A. Vessières, R. Alberto, *J. Organomet. Chem.* 600 (2000) 23.
- [135] T.R. Johnson, B.E. Mann, I.P. Teasdale, H. Adams, R. Foresti, C.J. Green, R. Motterlini, *Dalton Trans.* (2007) 1500.
- [136] D. Scapens, H. Adams, T.R. Johnson, B.E. Mann, P. Sawle, R. Aqil, T. Perrior, R. Motterlini, *Dalton Trans.* (2007) 4962.
- [137] V.D. Reddy, D. Dayal, S.C. Cosenza, M.V. Ramana Reddy, W.C. Pearl Jr., R.D. Adams, *J. Organomet. Chem.* 694 (2009) 959.
- [138] B. Therrien, W.H. Ang, F. Chérioux, L. Vieille-Petit, L. Juillerat-Jeanneret, G. Süß-Fink, P.J. Dyson, *J. Cluster Sci.* 18 (2007) 741.
- [139] M. Auzias, B. Therrien, G. Süß-Fink, *Inorg. Chim. Acta* 359 (2006) 3412.
- [140] F. Schmitt, M. Auzias, P. Štěpnička, Y. Sei, K. Yamaguchi, G. Süß-Fink, B. Therrien, L. Juillerat-Jeanneret, *J. Biol. Inorg. Chem.* 14 (2009) 693.